

Features

- Max Junction Temperature 175°C
- High breakdown voltage up to 650V for improved reliability
- Short Circuit Rated
- Very Low Saturation Voltage:
 $V_{CE(SAT)} = 1.65V$ (Typ.) @ $I_C = 20A$
- Soft current turn-off waveforms

V_{CE}	650	V
I_C	20	A
$V_{CE(SAT)} I_C=20A$	1.65	V

Applications

- Soft switching applications
- Air conditioning
- Motor drive inverter

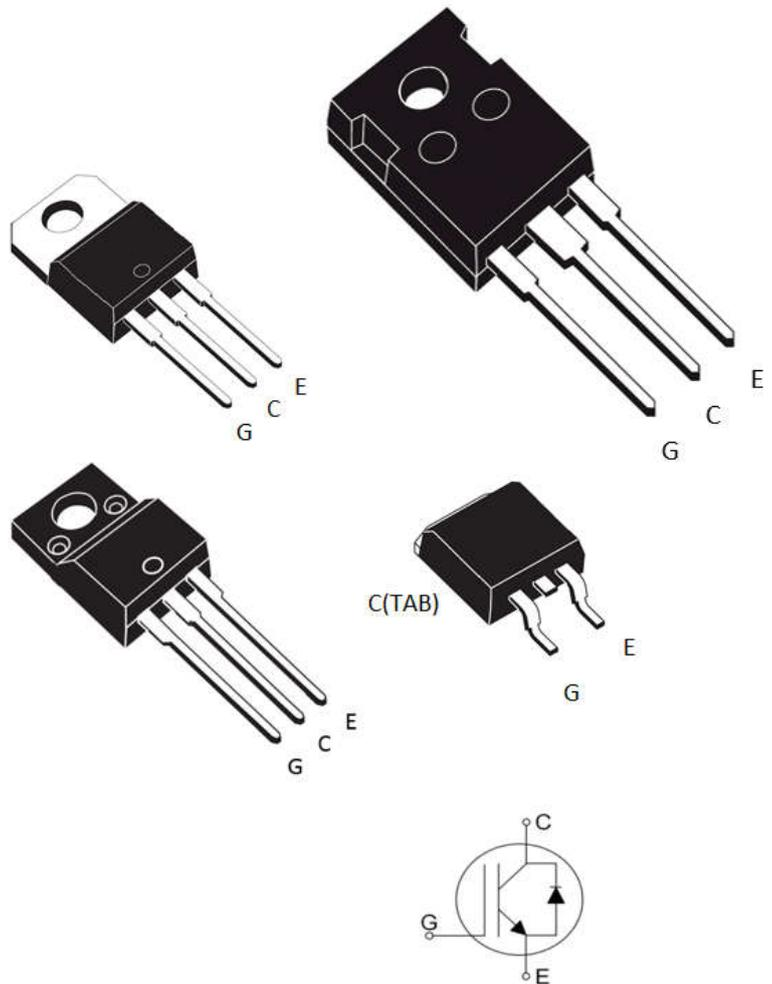

Product	Package	Packaging
YGF20N65T2	TO-220F	Tube
YGP20N65T2	TO-220	Tube
YGK20N65T2	TO-263	Tape and reel
YGW20N65T2	TO247	Tube

Maximum Ratings (T_j= 25°C unless otherwise specified)

Parameter	Symbol	Value	Unit
Collector-Emitter Breakdown Voltage	V _{CE}	650	V
DC collector current, limited by T _{jmax} T _C = 25°C T _C = 100°C	I _C	40 20	A
Diode Forward current, limited by T _{jmax} T _C = 25°C T _C = 100°C	I _F	40 20	A
Continuous Gate-emitter voltage	V _{GE}	±20	V
Transient Gate-emitter voltage	V _{GE}	±30	V
Turn off safe operating area V _{CE} ≤ 650V, T _j ≤ 175°C	-	60	A
Pulsed collector current, V _{GE} =15V, t _p limited by T _{jmax}	I _{CM}	60	A
Short Circuit Withstand Time, V _{GE} = 15V, V _{CE} ≤ 400V	T _{sc}	5	μs
TO-220F Power dissipation , T _j =25°C	P _{tot}	30.6	W
TO-220, TO-263, Power dissipation , T _j =25°C	P _{tot}	125	W
TO247 Power dissipation , T _j =25°C	P _{tot}	142	W
Operating junction temperature	T _j	-40...+175	°C
Storage temperature	T _s	-55...+175	°C
Soldering temperature, wave soldering 1.6mm (0.063in.) from case for 10s	-	260	°C
Mounting torque, M3 screw Maximum of mounting processes: 3	M	0.6	Nm

Thermal Resistance

Parameter	Symbol	TO-220F	TO-220, TO-263	TO247	Unit
IGBT thermal resistance, junction - case	R _{θ(j-c)}	4.9	1.2	1.05	K/W
Diode thermal resistance, junction - case	R _{θ(j-c)}	5.8	2.38	1.7	K/W
Thermal resistance, junction - ambient	R _{θ(j-a)}	62.5		40	K/W

Electrical Characteristics of the IGBT ($T_j = 25^\circ\text{C}$ unless otherwise specified)

Symbol	Parameter	Test Conditions	Min.	Typ.	Max.	Units
Static Characteristics (Tested on wafers)						
BV_{CES}	Collector to Emitter Breakdown Voltage	$V_{GE} = 0V, I_C = 1mA$	650	-	-	V
$V_{CE(SAT)}$	Collector to Emitter Saturation Voltage	$I_C = 20A, V_{GE} = 15V$	-	1.65	2.05	V
$V_{GE(th)}$	G-E Threshold Voltage	$V_{GE} = V_{CE}, I_C = 250\mu A$	4.4	5.4	6.4	V
I_{CES}	Collector Cut-Off Current	$V_{CE} = 650V, V_{GE} = 0V$	-	-	40	μA
I_{GES}	G-E Leakage Current	$V_{GE} = \pm 20V, V_{CE} = 0V$	-	-	± 200	nA
g_{fs}	Transconductance	$V_{CE} = 20V, I_C = 15A$	-	10	-	S

Parameter	Symbol	Conditions	Min	Typ	Max	Unit
Dynamic						
Input capacitance	C_{ies}	$V_{CE} = 25V, V_{GE} = 0V,$ $f = 1MHz$	-	1050	-	pF
Output capacitance	C_{oes}		-	50	-	
Reverse transfer capacitance	C_{res}		-	20	-	
Gate charge	Q_G	$V_{CC} = 520V, I_C = 20A,$ $V_{GE} = 15V$	-	45	-	nC
Short circuit collector current	$I_{C(SC)}$	$V_{GE} = 15V, t_{SC} \leq 5\mu s$ $V_{CC} = 400V,$ $T_{j, start} = 25^\circ C$	-	150	-	A

Switching Characteristic, Inductive Load ($T_j = 25^\circ\text{C}$ unless otherwise specified)

Parameter	Symbol	Conditions	Min.	Typ.	Max.	Unit
Dynamic						
Turn-on Delay Time	$t_{d(on)}$	$T_j = 25^\circ\text{C}$ $V_{CC} = 400\text{V}$, $I_C = 20\text{A}$, $V_{GE} = 0/15\text{V}$, $R_g = 20\Omega$	-	20	-	ns
Rise Time	t_r		-	40	-	ns
Turn-off Delay Time	$t_{d(off)}$		-	60	-	ns
Fall Time	t_f		-	75	-	ns
Turn-on Energy	E_{on}		-	0.47	-	mJ
Turn-off Energy	E_{off}		-	0.10	-	mJ

Electrical Characteristics of the DIODE ($T_j = 25^\circ\text{C}$ unless otherwise specified)

Parameter	Symbol	Conditions	Min	Typ	Max	Unit
Dynamic						
Diode Forward Voltage	V_{FM}	$I_F = 20\text{A}$	-	1.9	-	V
Reverse Recovery Time	T_{rr}	$I_F = 15\text{A}$ $V_R = 300\text{V}$, $di/dt = 200\text{A}/\mu\text{s}$	-	50	-	ns
Reverse Recovery Current	I_{rr}		-	4	-	A
Reverse Recovery Charge	Q_{rr}		-	83	-	nC

Fig. 1 FBSOA characteristics for TO-220F

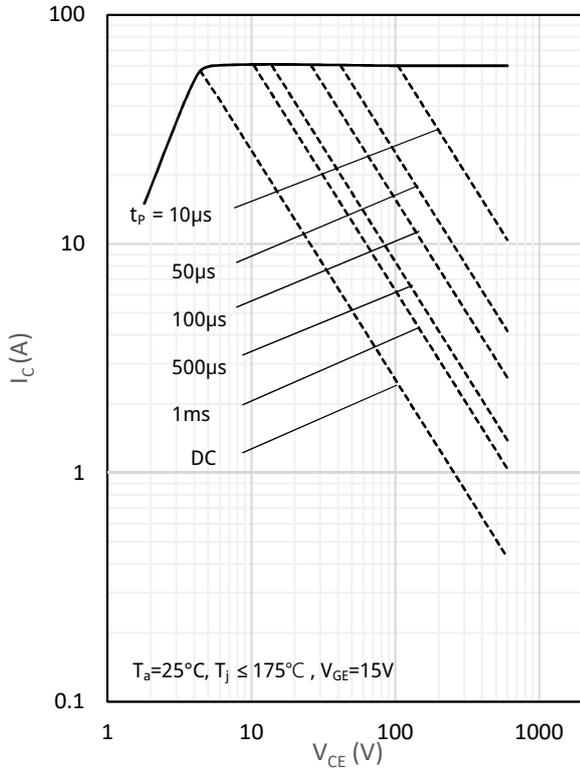

Fig. 2 FBSOA characteristics for TO-220 and TO-263

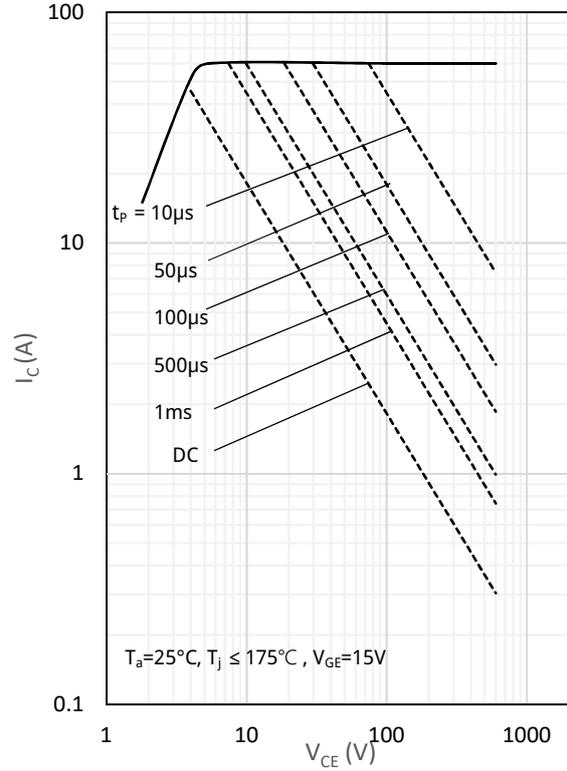

Fig. 3 Load Current vs. Frequency for TO-220F

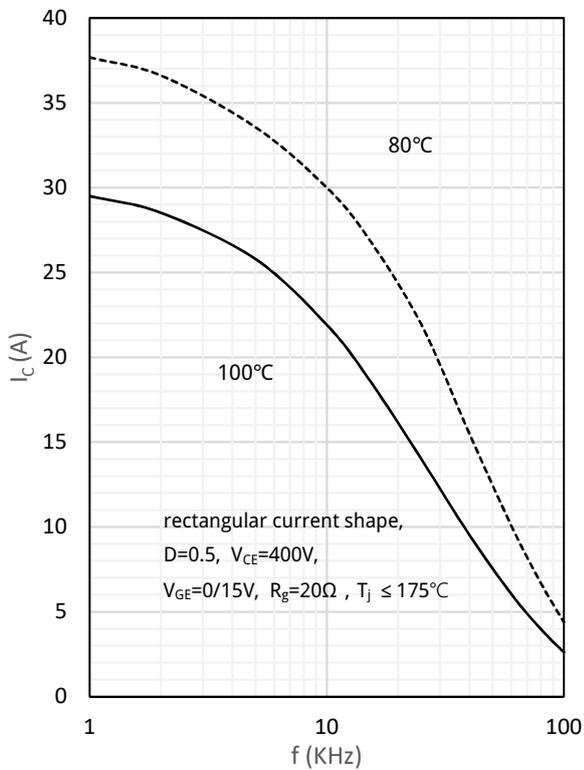

Fig.4 Load Current vs. Frequency TO-220 and TO-263

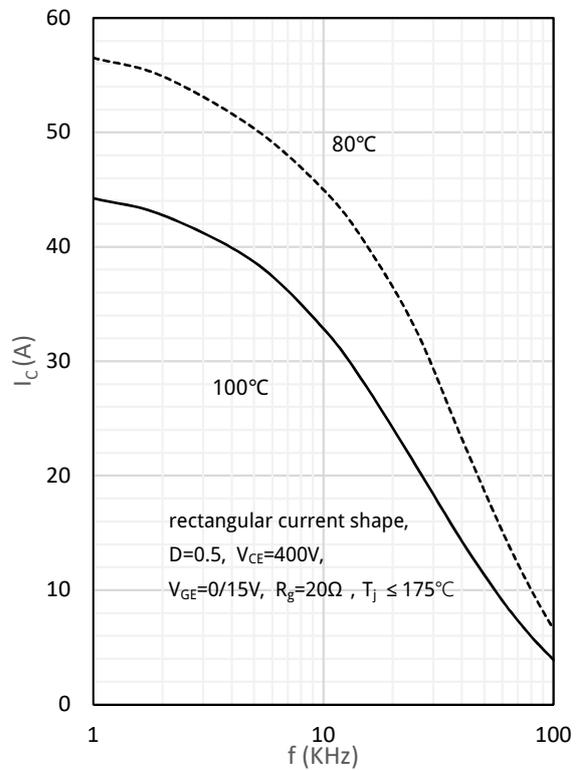

Fig.5 FBSOA characteristics for TO-247

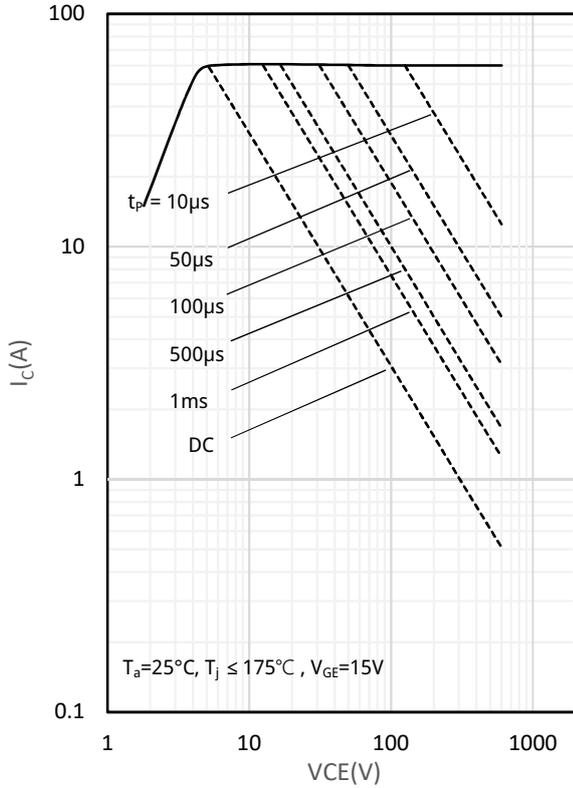

Fig.6 Load Current vs. Frequency for TO-247

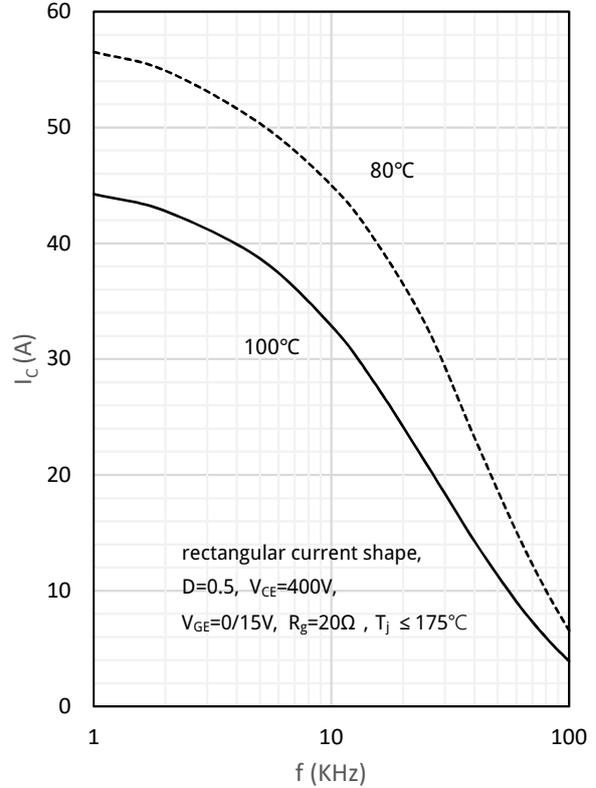

Fig. 7 Output characteristics

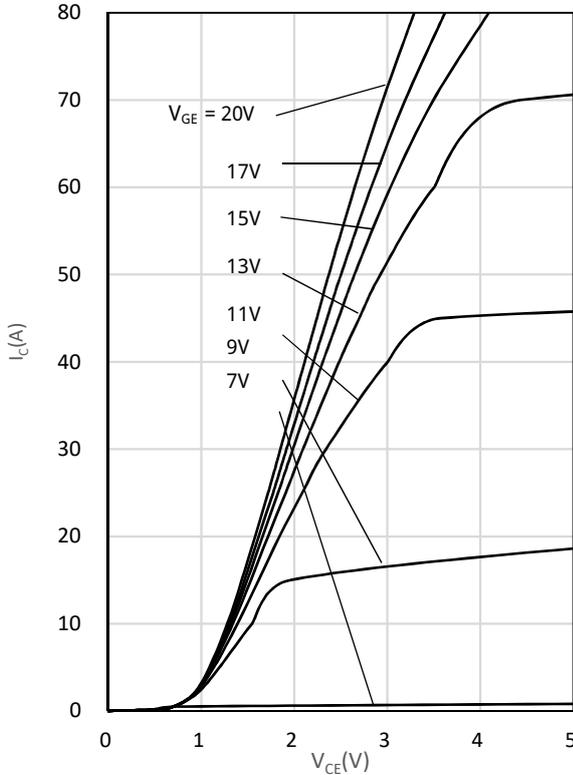

Fig. 8 Saturation voltage characteristics

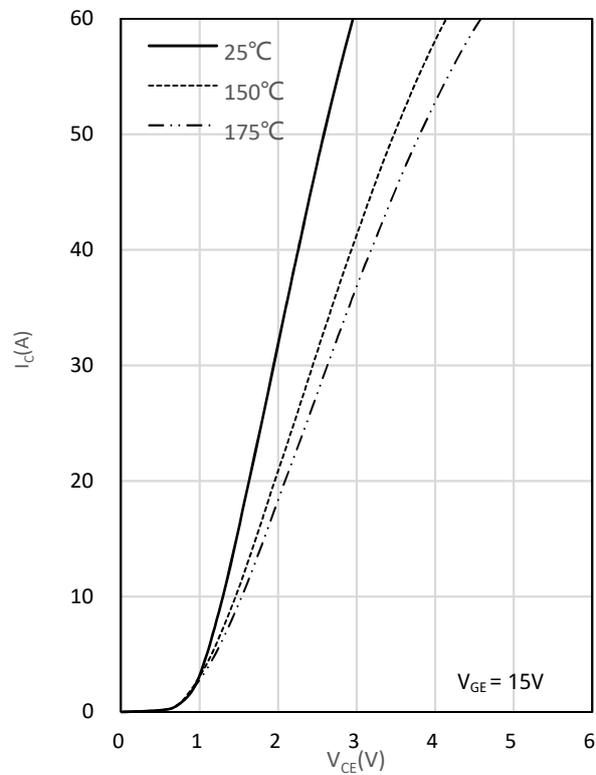

Fig. 9 Switching times vs. gate resistor

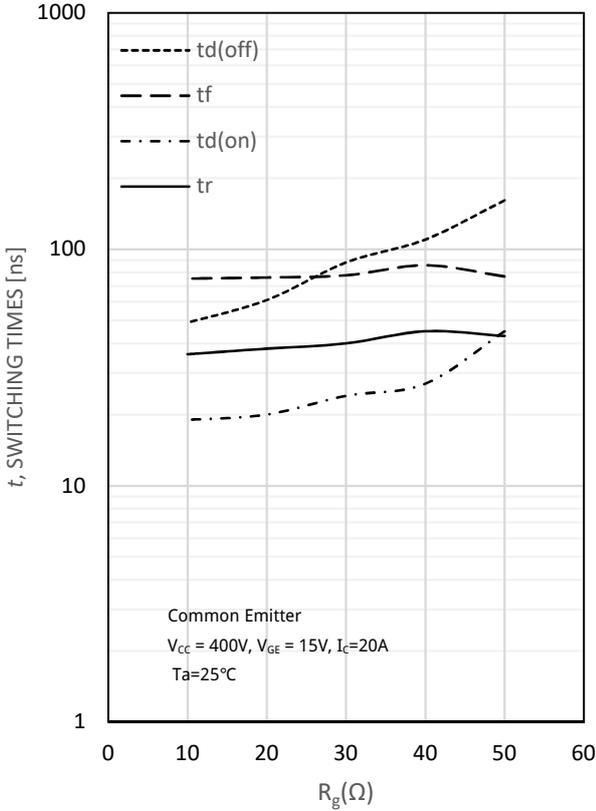

Fig. 10 Switching times vs. collector current

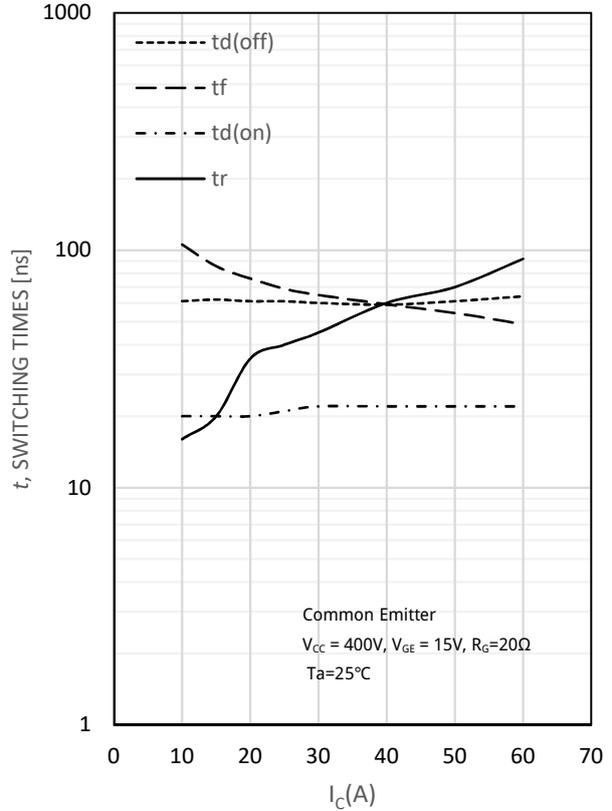

Fig. 11 Switching loss vs. gate resistor

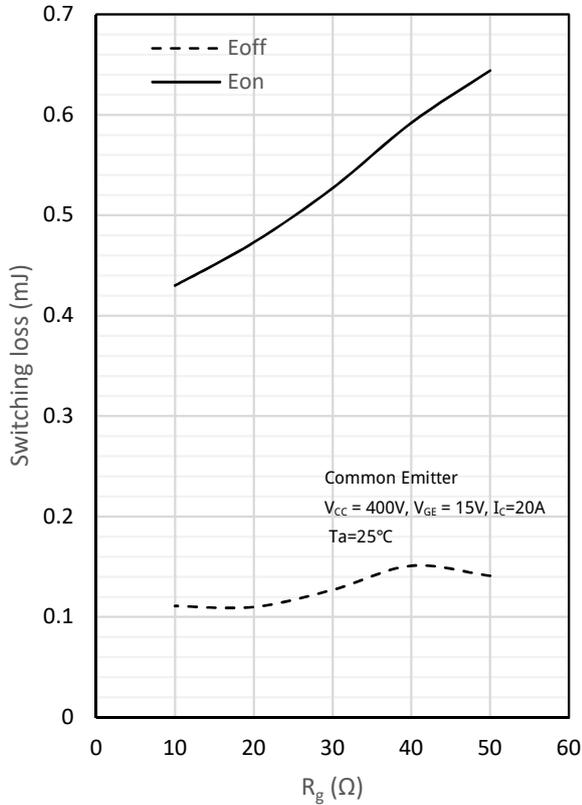

Fig. 12 Switching loss vs. collector current

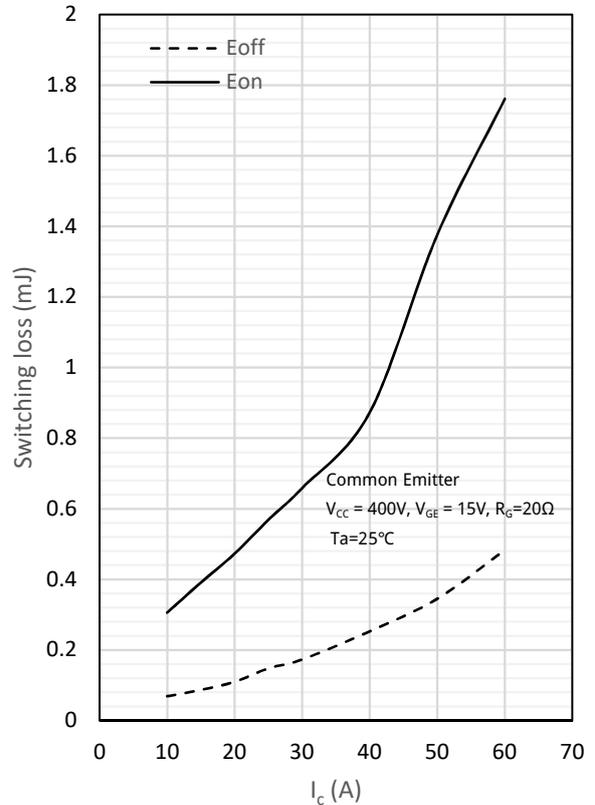

Fig. 13 Gate charge characteristics

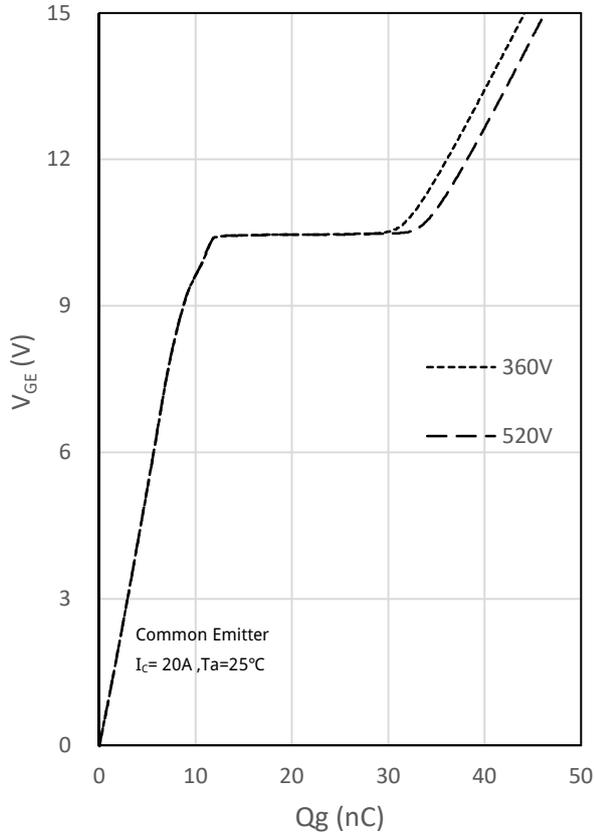
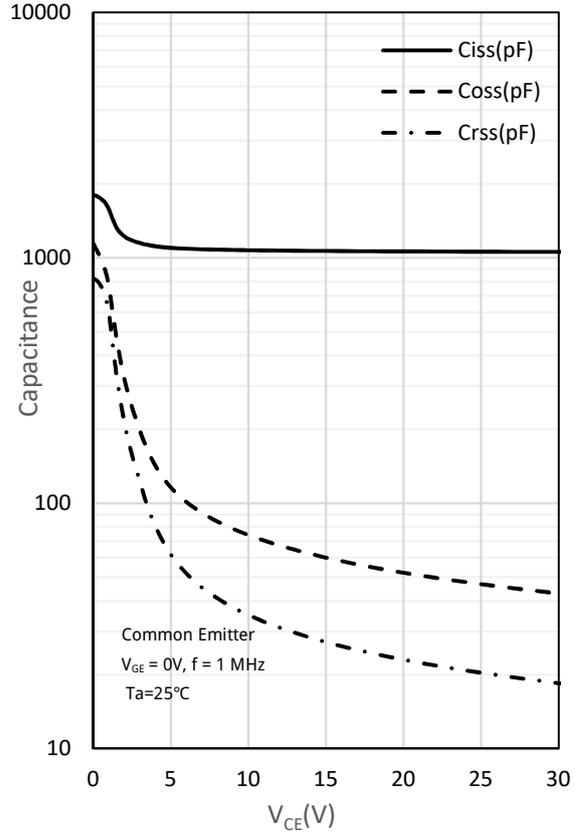
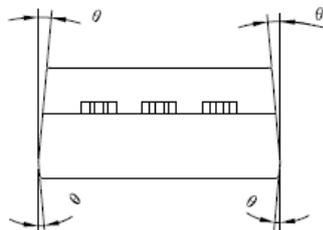
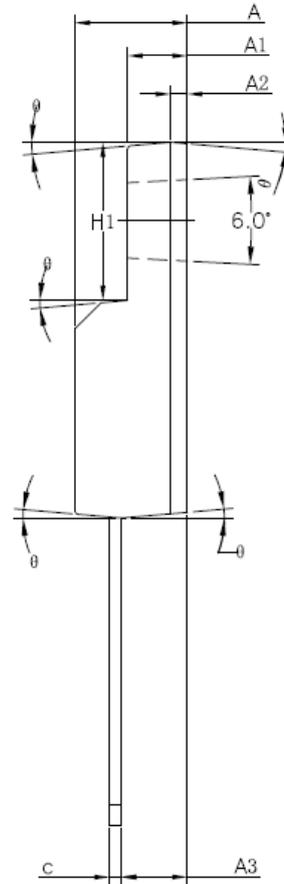
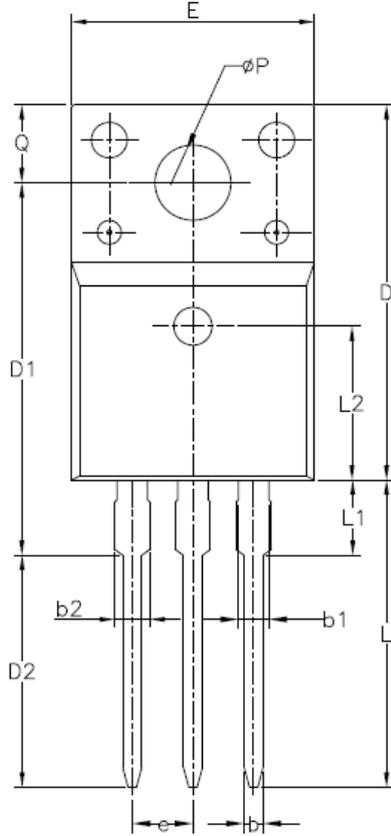

Fig. 14 Capacitance characteristics



TO-220F package information

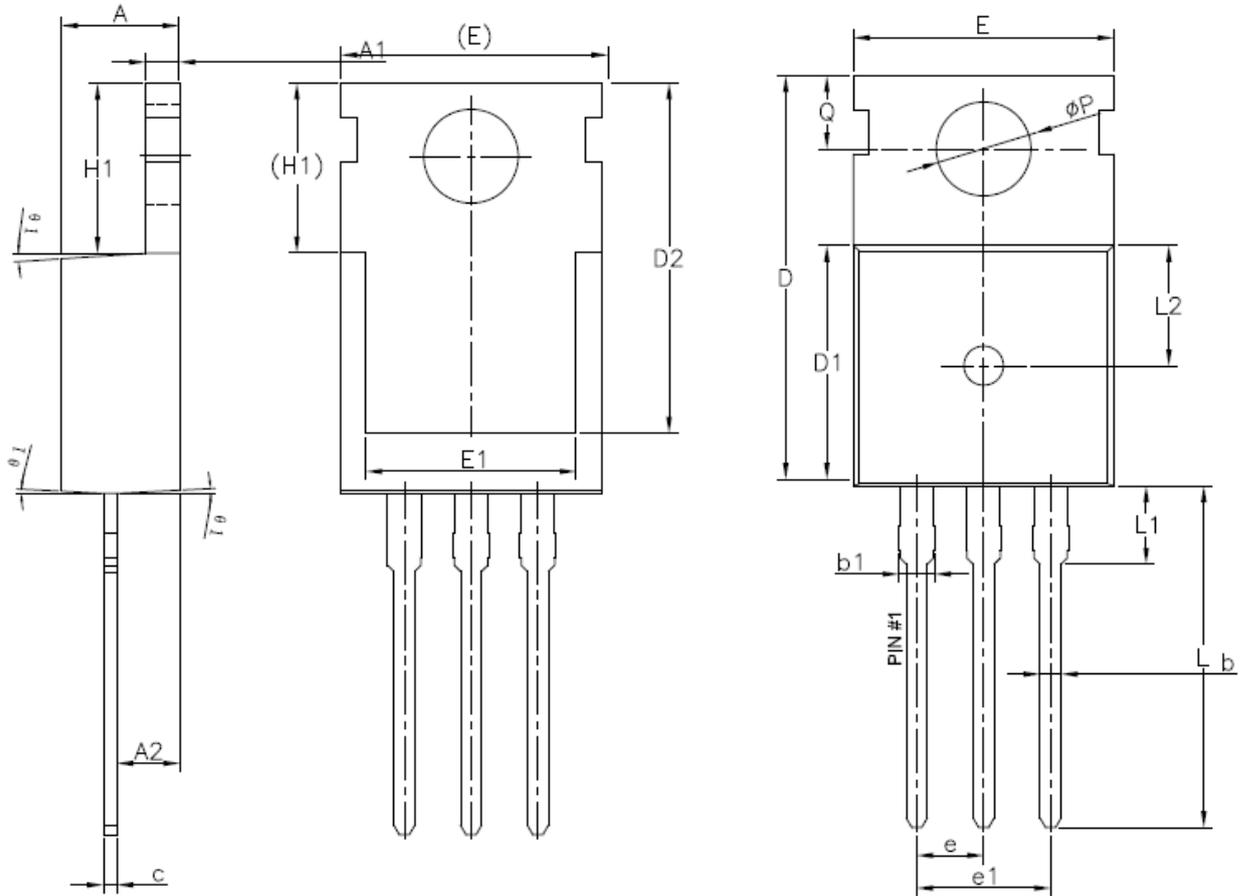

SYMBOL	MIN	NOM	MAX
A	4.50	4.70	4.83
A1	2.34	2.54	2.74
A2	0.70 REF		
A3	2.56	2.76	2.93
b	0.70	-	0.90
b1	1.18	-	1.38
b2	-	-	1.47
c	0.45	0.50	0.60
D	15.67	15.87	16.07
D1	15.55	15.75	15.95
D2	9.60	9.80	10.0
E	9.96	10.16	10.36
e	2.54BSC		
H1	6.48	6.68	6.88
L	12.68	12.98	13.28
L1	-	-	3.50
L2	6.50REF		
ϕP	3.08	3.18	3.28
Q	3.20	-	3.40
$\theta 1$	1°	3°	5°

TO-220 package information

SYMBOL	MIN	NOM	MAX
A	4.40	4.50	4.60
A1	1.27	1.30	1.33
A2	2.30	2.40	2.50
b	0.70	—	0.90
b1	1.27	—	1.40
c	0.45	0.50	0.60
D	15.30	15.70	16.10
D1	9.10	9.20	9.30
D2	13.10	—	13.70
E	9.70	9.90	10.20
E1	7.80	8.00	8.20
e	2.49	2.54	2.59
e1	5.03	5.08	5.12
H1	6.30	6.50	6.70
L	12.78	13.08	13.38
L1	3.30	—	3.50
L2	4.50	4.60	4.70
∅P	3.55	3.60	3.65
Q	2.73	—	2.87
θ ₁	1°	3°	5°

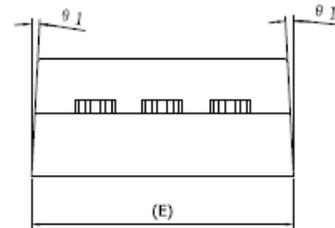

TO247 package information

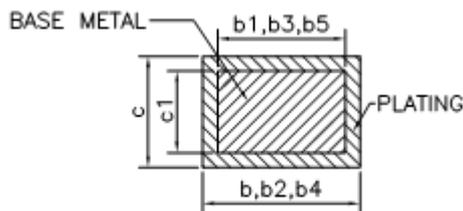
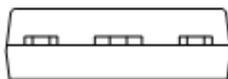
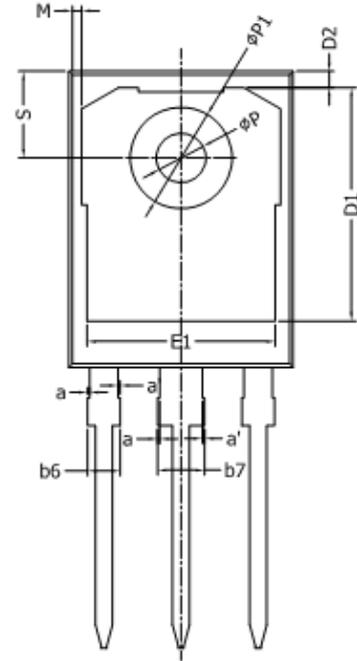
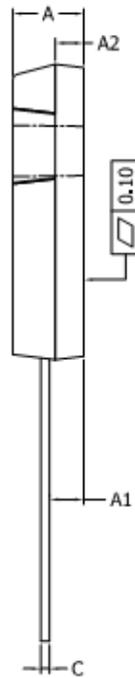
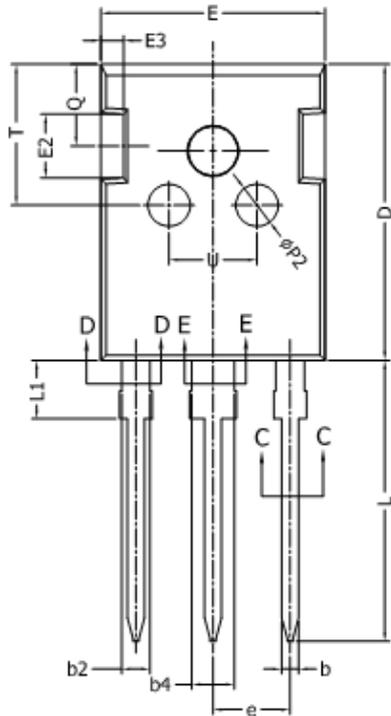

SECTION C-C, D-D & E-E

COMMON DIMENSIONS
(UNITS OF MEASURE = MILLIMETER)

SYMBOL	MIN	NOM	MAX
A	4.90	5.00	5.10
A1	2.31	2.41	2.51
A2	1.90	2.00	2.10
a	0	--	0.15
a'	0	--	0.15
b	1.16	--	1.26
b1	1.15	1.2	1.22
b2	1.96	--	2.06
b3	1.95	2.00	2.02
b4	2.96	--	3.06
b5	2.96	3.00	3.02
b6	2.00	--	2.25
b7	3.00	--	3.25
c	0.59	--	0.66
c1	0.58	0.60	0.62
D	20.90	21.00	21.10
D1	16.25	16.55	16.85
D2	1.05	1.17	1.35
E	15.70	15.80	15.90
E1	13.10	13.30	13.50
E2	4.40	4.50	4.60
E3	1.50	1.60	1.70
e	5.336	5.436	5.53
L	19.80	19.92	20.10
L1	4.10	--	4.30
M	0.35	--	0.95
P	3.40	3.50	3.60
P1	7.00	--	7.40
P2	2.40	2.50	2.60
Q	5.60	--	6.00
S	6.05	6.15	6.25
T	9.80	--	10.20
U	6.00	--	6.40