

Raspberry Pi 15.3W USB-C Power Supply

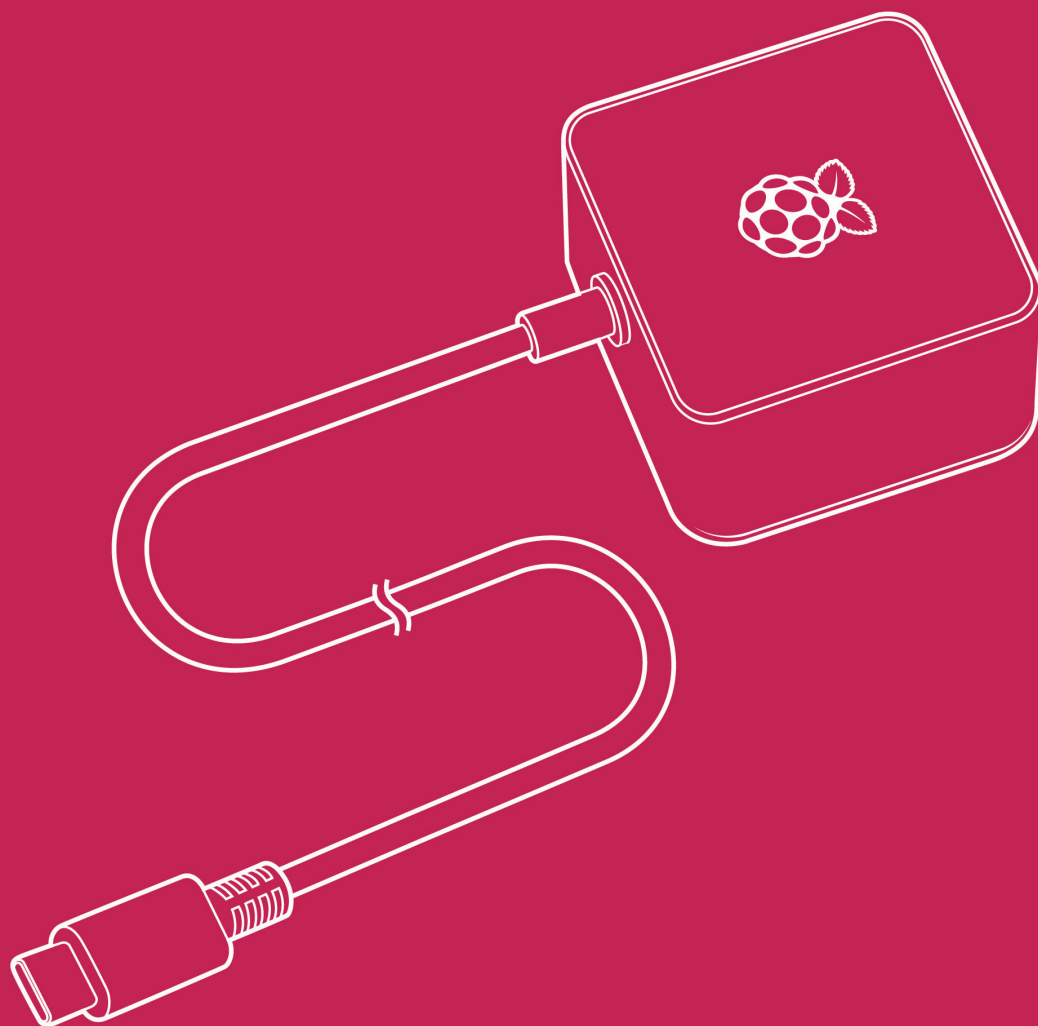

Published in June 2019
by Raspberry Pi Trading Ltd.

www.raspberrypi.org



Raspberry Pi

Overview

The official Raspberry Pi USB-C power supply is designed to power the latest Raspberry Pi 4 Model B computers, which were released in June 2019.

Featuring a captive USB-C cable, the power supply is available in four different models to suit different international power sockets, and in two colours, white and black.



Specification

Output

Output voltage:	+5.1V DC
Minimum load current:	0A
Nominal load current:	3.0A
Maximum power:	15.3W
Load regulation:	±5%
Line regulation:	±2%
Ripple & noise:	120mVp-p
Rise time:	100ms maximum to regulation limits for DC outputs
Turn-on delay:	3000ms maximum at nominal input AC voltage and full load
Protection:	Short circuit protection Overcurrent protection Over temperature protection
Efficiency:	81% minimum (output current from 100%, 75%, 50%, 25%) 72% minimum at 10% load
Output cable:	1.5m 18AWG
Output connector:	USB Type-C

Input

Voltage range:	100-240Vac (rated) 96-264Vac (operating)
Frequency:	50/60Hz ±3Hz
Current:	0.5A maximum
Power consumption (no load):	0.075W maximum
Inrush current:	No damage shall occur and the input fuse shall not blow

Plug styles

Part number	Colour	Plug Style	Plug Type
KSA-15E-051300HA White	White	Australia	Type I
KSA-15E-051300HA Black	Black	New Zealand	
		China	
KSA-15E-051300HE White	White	Europe, India	Type C
KSA-15E-051300HE Black	Black		
KSA-15E-051300HK White	White	UK	Type G
KSA-15E-051300HK Black	Black		
KSA-15E-051300HU White	White	US, Canada	Type A
KSA-15E-051300HU Black	Black		

Environment

Operating ambient temperature 0–40°C

Compliance

For a full list of local and regional product approvals, please visit

www.raspberrypi.org/documentation/hardware/raspberrypi/conformity.md

Physical Specifications

KSA-15E-051300HA

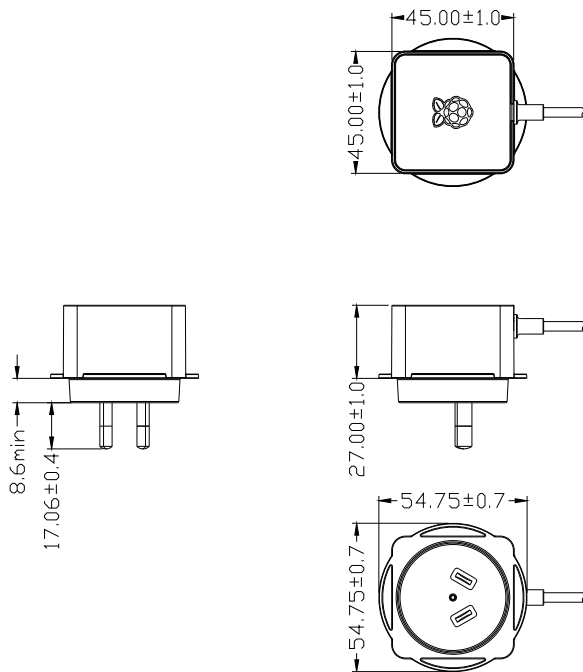

Note: all dimensions in mm

KSA-15E-051300HE

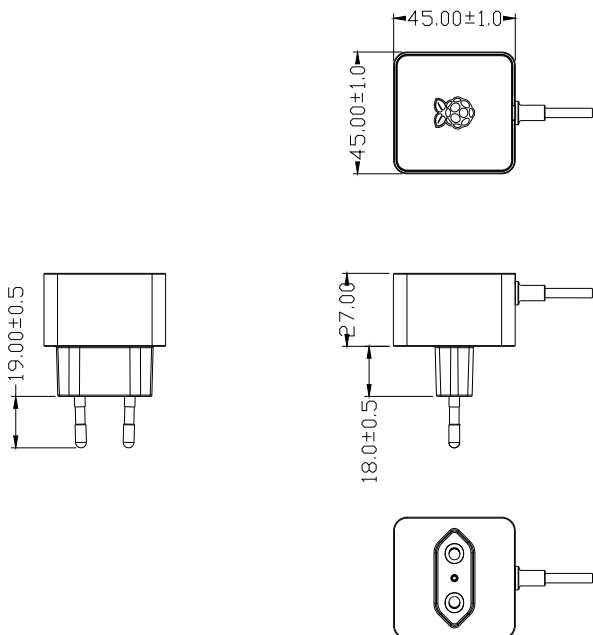

Note: all dimensions in mm

KSA-15E-051300HK

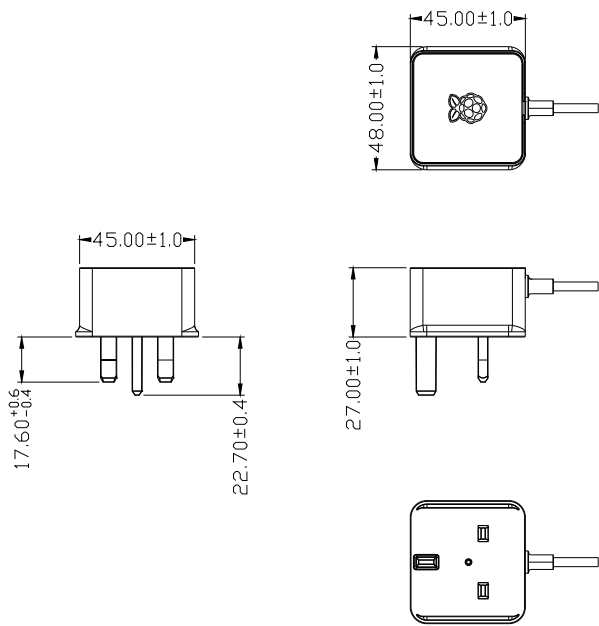

Note: all dimensions in mm

KSA-15E-051300HU

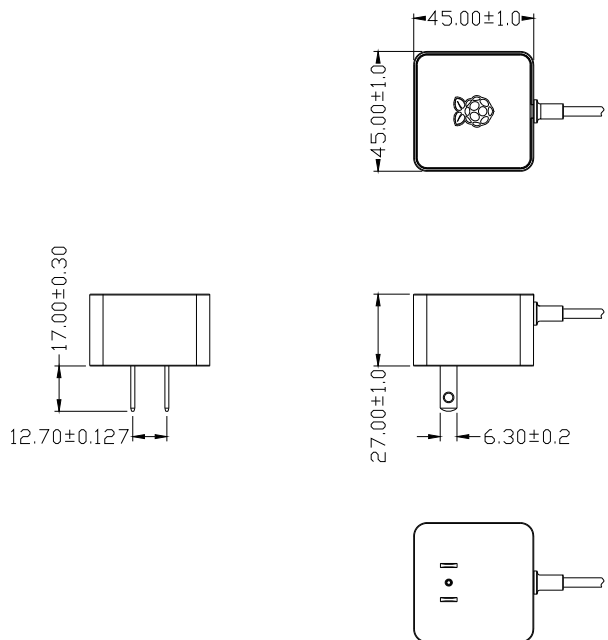

Note: all dimensions in mm

Case material

UL94V-1

AC pin material

Brass (NI plated)

DC cord & output plug

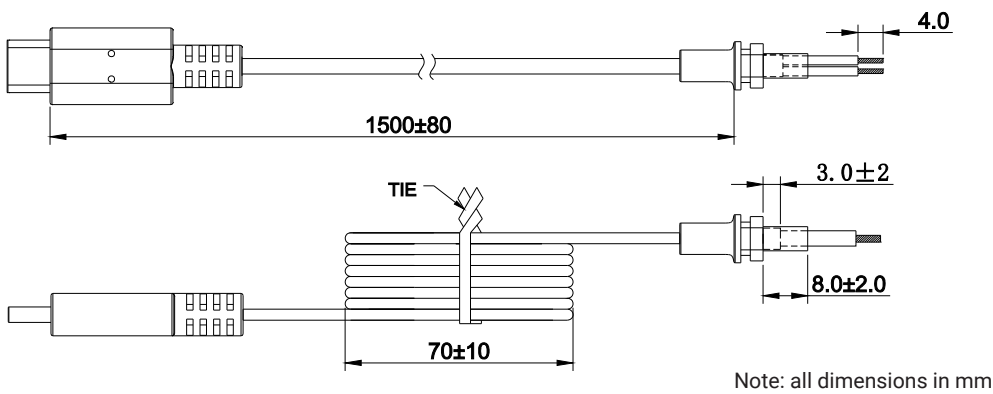

WARNINGS

- This product should be operated in a well-ventilated environment.
- The connection of incompatible devices to this power supply may affect compliance, result in damage to the unit and invalidate the warranty.

SAFETY INSTRUCTIONS

To avoid malfunction or damage to this product please observe the following:

- Do not expose to water or moisture, or place on a conductive surface whilst in operation.
- Do not expose to heat from any source; this is designed for reliable operation at normal ambient room temperatures.
- Do not attempt to open or remove the power supply case.

Raspberry Pi is a trademark of the Raspberry Pi Foundation

www.raspberrypi.org

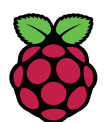

Raspberry Pi