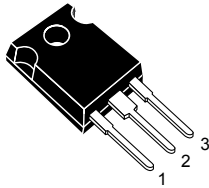
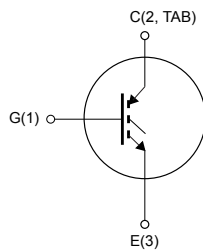

Trench gate field-stop, 600 V, 60 A, very high speed, V series IGBT in a TO-247 package

TO-247

G1C2TE3

Features

- Maximum junction temperature: $T_J = 175\text{ °C}$
- Tail-less switching off
- $V_{CE(sat)} = 1.85\text{ V (typ.) @ } I_C = 60\text{ A}$
- Tight parameter distribution
- Safe paralleling
- Low thermal resistance

Applications

- Photovoltaic inverters
- Uninterruptible power supply
- Welding
- Power factor correction
- Very high frequency converters

Description

This device is an IGBT developed using an advanced proprietary trench gate field-stop structure. The device is part of the V series IGBTs, which represent an optimum compromise between conduction and switching losses to maximize the efficiency of very high frequency converters. Furthermore, the positive $V_{CE(sat)}$ temperature coefficient and very tight parameter distribution result in safer paralleling operation.

Product status link

[STGW60V60F](#)

Product summary

Order code	STGW60V60F
Marking	GW60V60F
Package	TO-247
Packing	Tube

1 Electrical ratings

Table 1. Absolute maximum ratings

Symbol	Parameter	Value	Unit
V_{CES}	Collector-emitter voltage ($V_{GE} = 0\text{ V}$)	600	V
I_C	Continuous collector current at $T_C = 25\text{ °C}$	80 ⁽¹⁾	A
	Continuous collector current at $T_C = 100\text{ °C}$	60	
$I_{CP}^{(2)}$	Pulsed collector current	240	A
V_{GE}	Gate-emitter voltage	± 20	V
P_{TOT}	Total dissipation at $T_C = 25\text{ °C}$	375	W
T_{STG}	Storage temperature range	-55 to 150	°C
T_J	Operating junction temperature range	-55 to 175	°C

1. Current level is limited by bond wires.

2. Pulse width limited by maximum junction temperature and turn-off within RBSOA

Table 2. Thermal data

Symbol	Parameter	Value	Unit
R_{thJC}	Thermal resistance junction-case IGBT	0.4	°C/W
R_{thJA}	Thermal resistance junction-ambient	50	°C/W

2 Electrical characteristics

$T_J = 25\text{ °C}$ unless otherwise specified

Table 3. Static characteristics

Symbol	Parameter	Test conditions	Min.	Typ.	Max.	Unit
$V_{(BR)CES}$	Collector-emitter breakdown voltage	$V_{GE} = 0\text{ V}$, $I_C = 2\text{ mA}$	600			V
$V_{CE(sat)}$	Collector-emitter saturation voltage	$V_{GE} = 15\text{ V}$, $I_C = 60\text{ A}$		1.85	2.3	V
		$V_{GE} = 15\text{ V}$, $I_C = 60\text{ A}$, $T_J = 125\text{ °C}$		2.15		
		$V_{GE} = 15\text{ V}$, $I_C = 60\text{ A}$, $T_J = 175\text{ °C}$		2.35		
$V_{GE(th)}$	Gate threshold voltage	$V_{CE} = V_{GE}$, $I_C = 1\text{ mA}$	5.0	6.0	7.0	V
I_{CES}	Collector cut-off current	$V_{GE} = 0\text{ V}$, $V_{CE} = 600\text{ V}$			25	μA
I_{GES}	Gate-emitter leakage current	$V_{CE} = 0\text{ V}$, $V_{GE} = \pm 20\text{ V}$			± 250	nA

Table 4. Dynamic characteristics

Symbol	Parameter	Test conditions	Min.	Typ.	Max.	Unit
C_{ies}	Input capacitance	$V_{CE} = 25\text{ V}$, $f = 1\text{ MHz}$, $V_{GE} = 0\text{ V}$	-	8000	-	pF
C_{oes}	Output capacitance		-	280	-	pF
C_{res}	Reverse transfer capacitance		-	170	-	pF
Q_g	Total gate charge	$V_{CC} = 480\text{ V}$, $I_C = 60\text{ A}$, $V_{GE} = 0\text{ to }15\text{ V}$ (see Figure 22. Gate charge test circuit)	-	334	-	nC
Q_{ge}	Gate-emitter charge		-	130	-	nC
Q_{gc}	Gate-collector charge		-	58	-	nC

Table 5. IGBT switching characteristics (inductive load)

Symbol	Parameter	Test conditions	Min.	Typ.	Max.	Unit
$t_{d(on)}^{(1)}$	Turn-on delay time	$V_{CE} = 400\text{ V}$, $I_C = 60\text{ A}$, $R_G = 4.7\ \Omega$, $V_{GE} = 15\text{ V}$ (see Figure 21. Test circuit for inductive load switching)	-	60	-	ns
$t_r^{(1)}$	Current rise time		-	20	-	ns
$(di/dt)_{on}^{(1)}$	Turn-on current slope		-	2365	-	A/ μs
$t_{d(off)}$	Turn-off delay time		-	208	-	ns
t_f	Current fall time		-	14	-	ns
$E_{on}^{(1)}$	Turn-on switching energy		-	0.75	-	mJ
$E_{off}^{(2)}$	Turn-off switching energy		-	0.55	-	mJ
E_{ts}	Total switching energy		-	1.3	-	mJ

Symbol	Parameter	Test conditions	Min.	Typ.	Max.	Unit
$t_{d(on)}^{(1)}$	Turn-on delay time	$V_{CE} = 400\text{ V}$, $I_C = 60\text{ A}$, $R_G = 4.7\ \Omega$, $V_{GE} = 15\text{ V}$, $T_J = 175\text{ }^\circ\text{C}$ (see Figure 21. Test circuit for inductive load switching)	-	57	-	ns
$t_r^{(1)}$	Current rise time		-	23	-	ns
$(di/dt)_{on}^{(1)}$	Turn-on current slope		-	2191	-	A/ μs
$t_{d(off)}$	Turn-off delay time		-	216	-	ns
t_f	Current fall time		-	27	-	ns
$E_{on}^{(1)}$	Turn-on switching energy		-	1.5	-	mJ
$E_{off}^{(2)}$	Turn-off switching energy		-	0.8	-	mJ
E_{ts}	Total switching energy		-	2.3	-	mJ

- Switching-on times and energy have been calculated applying the STGW60V60DF's co-pack diode in the high side of the test circuit shown in [Figure 21. Test circuit for inductive load switching](#). Both the IGBT and the diode are at the same temperature. The turn-on switching energies include the reverse recovery of the diode.
- Including the tail of the collector current.

2.1 Electrical characteristics (curves)

Figure 1. Power dissipation vs case temperature

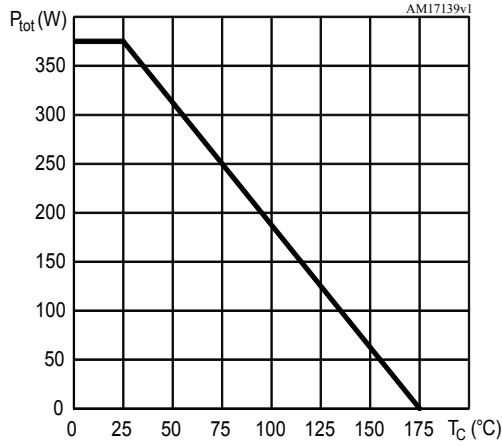

Figure 2. Collector current vs case temperature

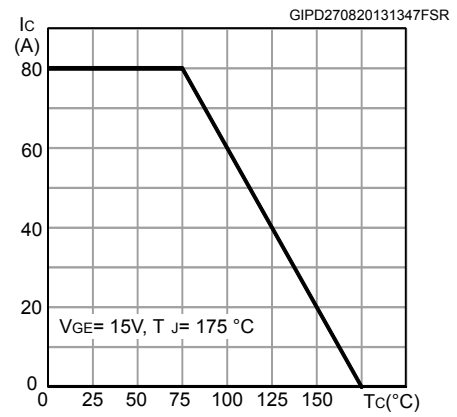

Figure 3. Output characteristics ($T_J = 25^\circ\text{C}$)

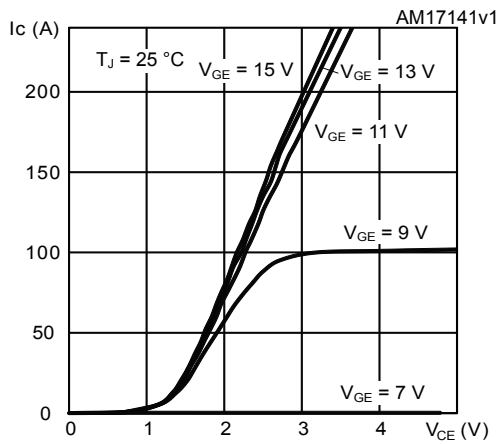

Figure 4. Output characteristics ($T_J = 175^\circ\text{C}$)

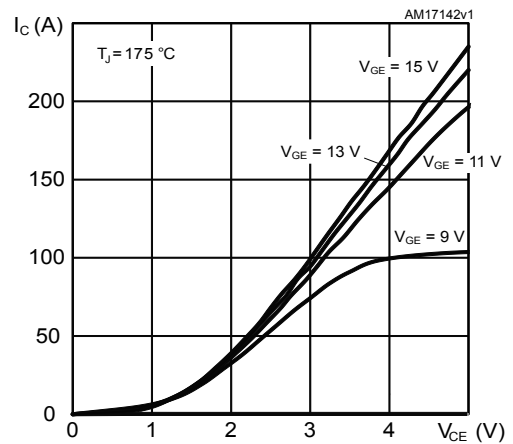

Figure 5. $V_{CE(sat)}$ vs junction temperature

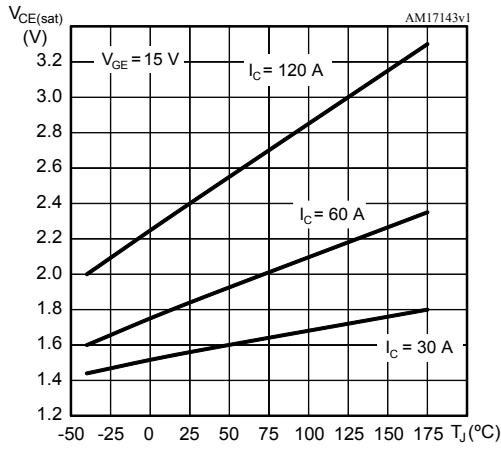

Figure 6. $V_{CE(sat)}$ vs collector current

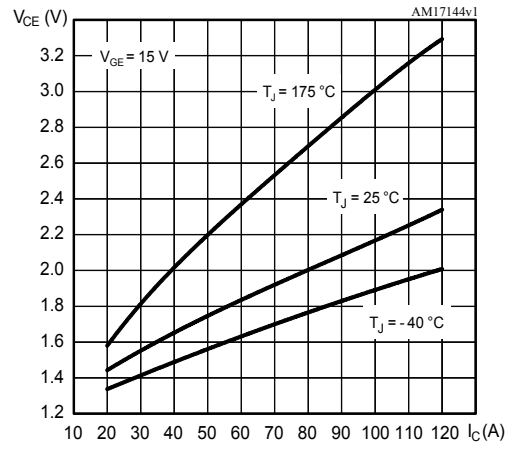

Figure 7. Collector current vs switching frequency

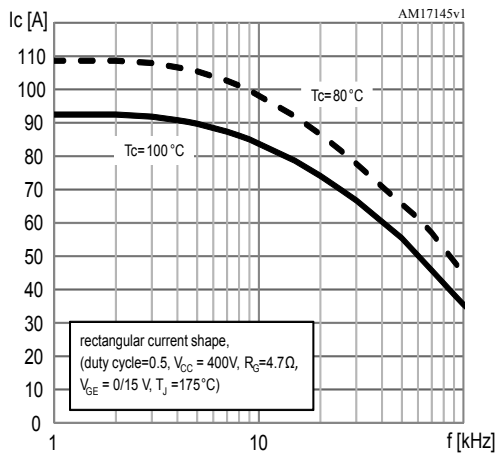

Figure 8. Forward bias safe operating area

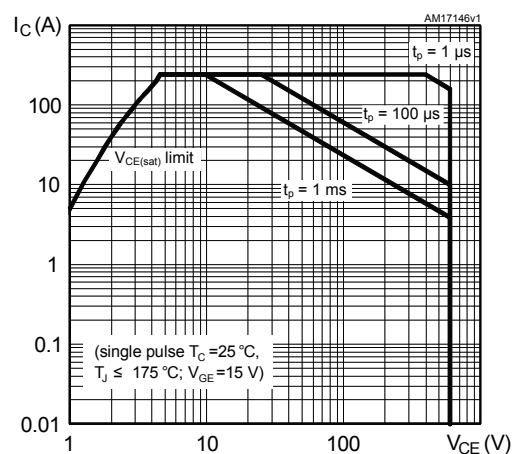

Figure 9. Transfer characteristics

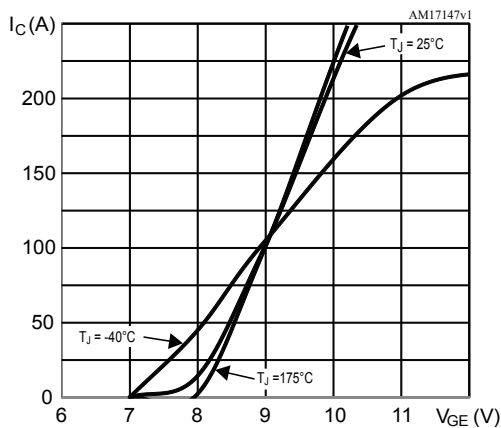

Figure 10. Normalized $V_{GE(th)}$ vs junction temperature

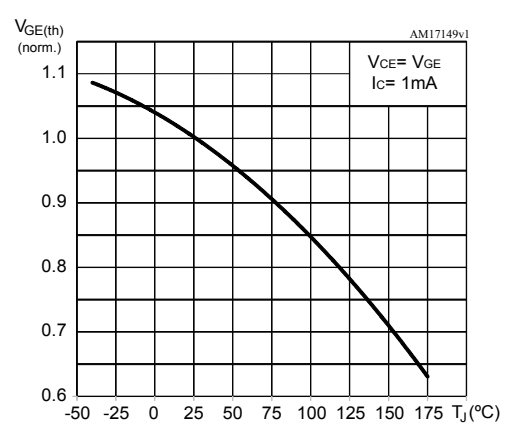

Figure 11. Normalized $V_{(BR)CES}$ vs junction temperature

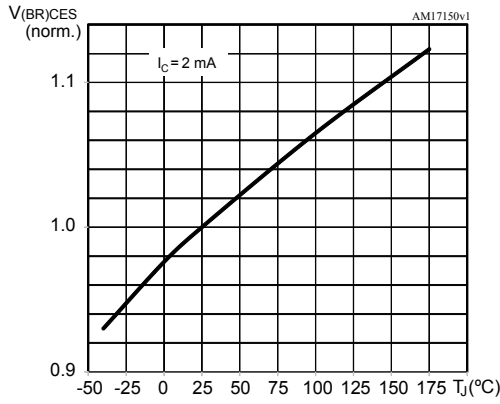

Figure 12. Capacitance variation

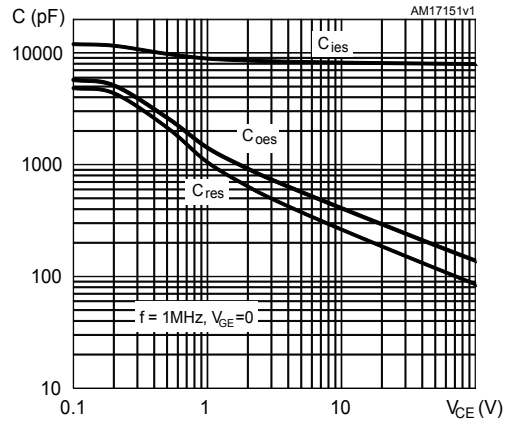

Figure 13. Gate charge vs gate-emitter voltage

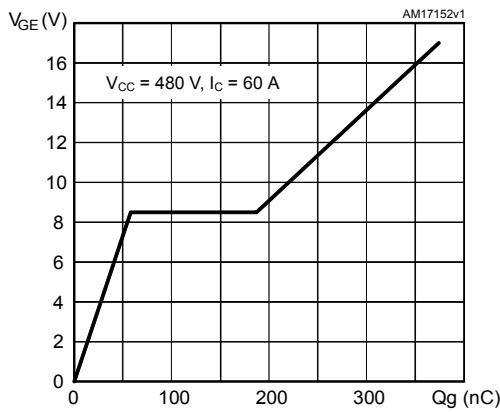

Figure 14. Switching energy vs collector current

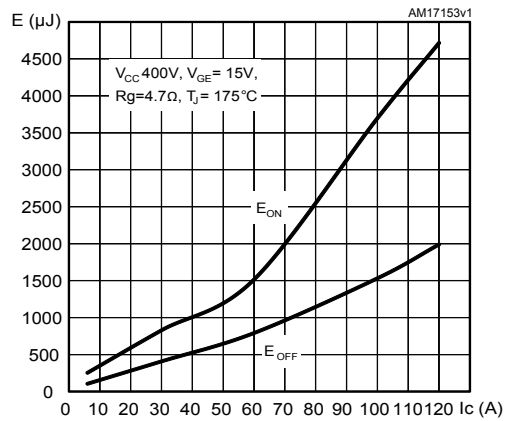

Figure 15. Switching energy vs gate resistance

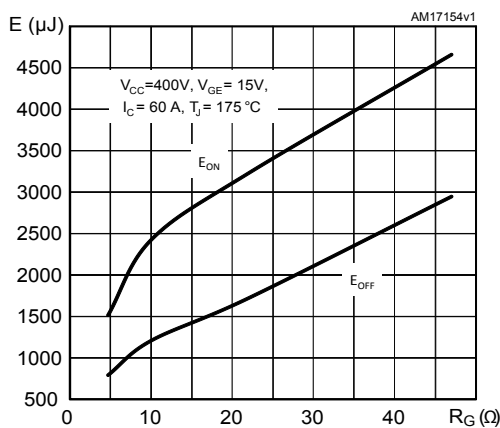

Figure 16. Switching energy vs temperature

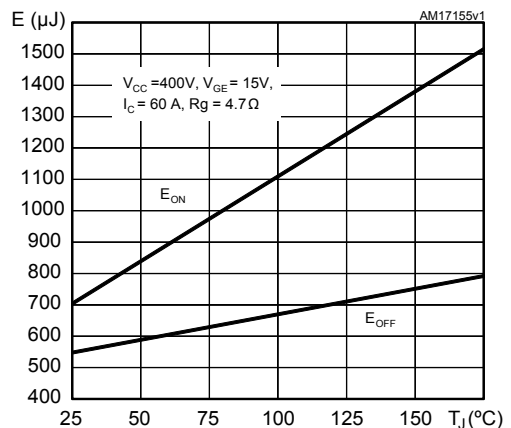

Figure 17. Switching energy vs collector-emitter voltage

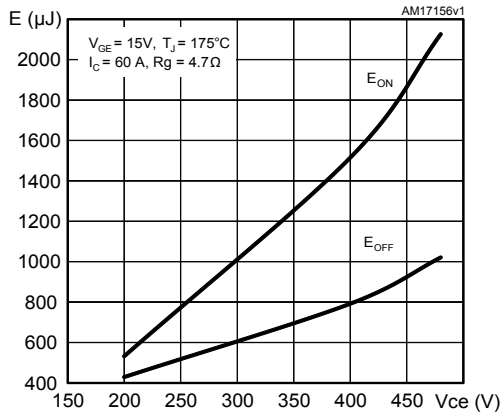

Figure 18. Switching times vs collector current

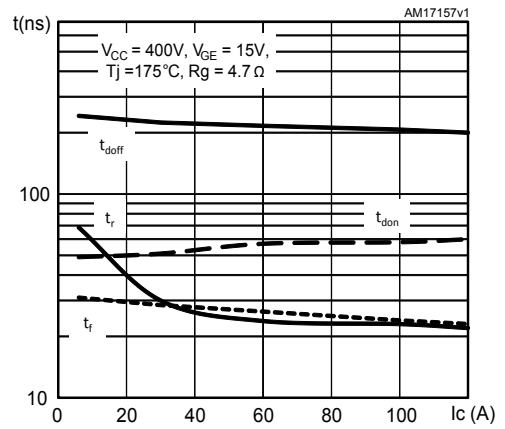

Figure 19. Switching times vs gate resistance

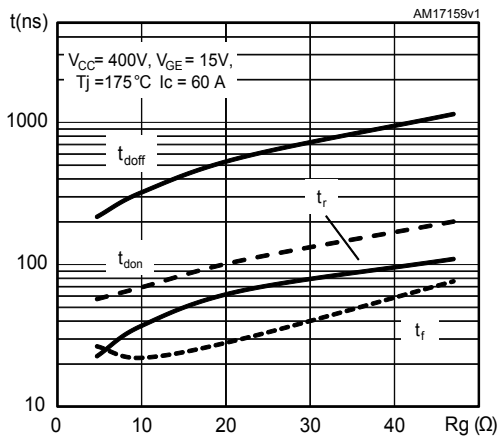
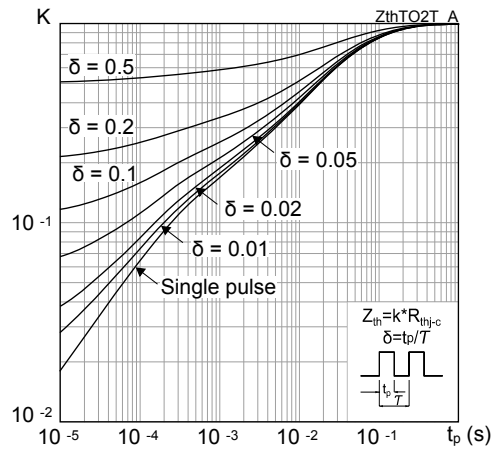
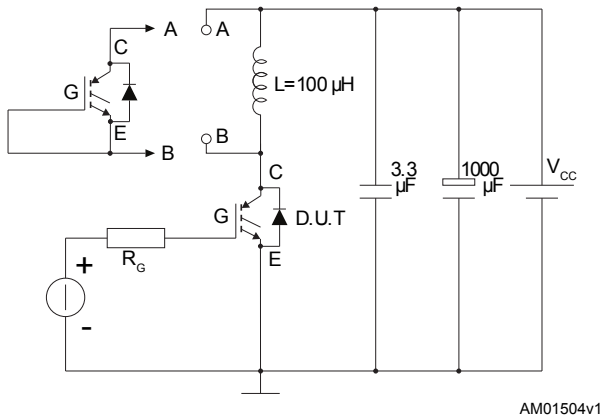
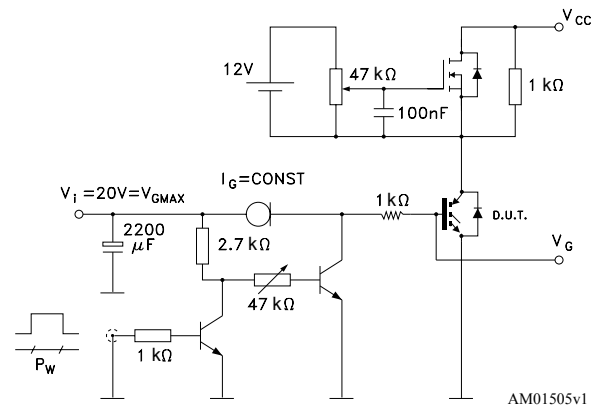
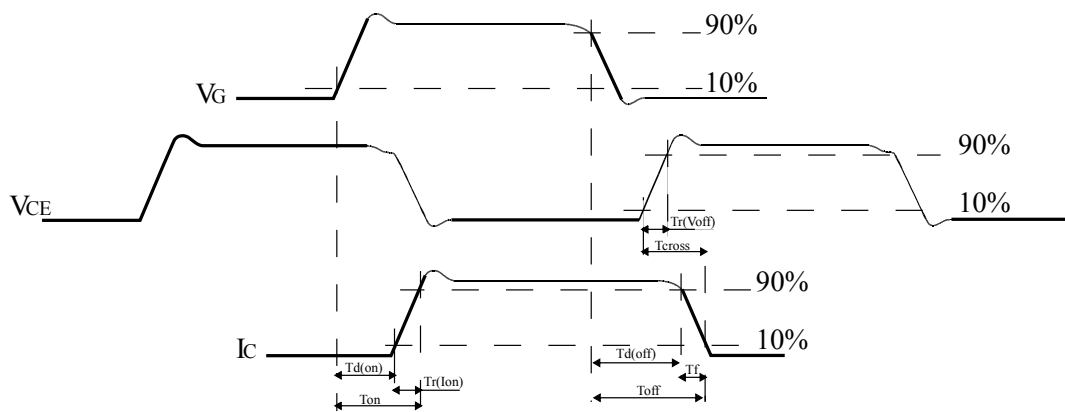

Figure 20. Thermal impedance



3 Test circuits

Figure 21. Test circuit for inductive load switching

Figure 22. Gate charge test circuit

Figure 23. Switching waveform

4 Package information

In order to meet environmental requirements, ST offers these devices in different grades of ECOPACK® packages, depending on their level of environmental compliance. ECOPACK® specifications, grade definitions and product status are available at: www.st.com. ECOPACK® is an ST trademark.

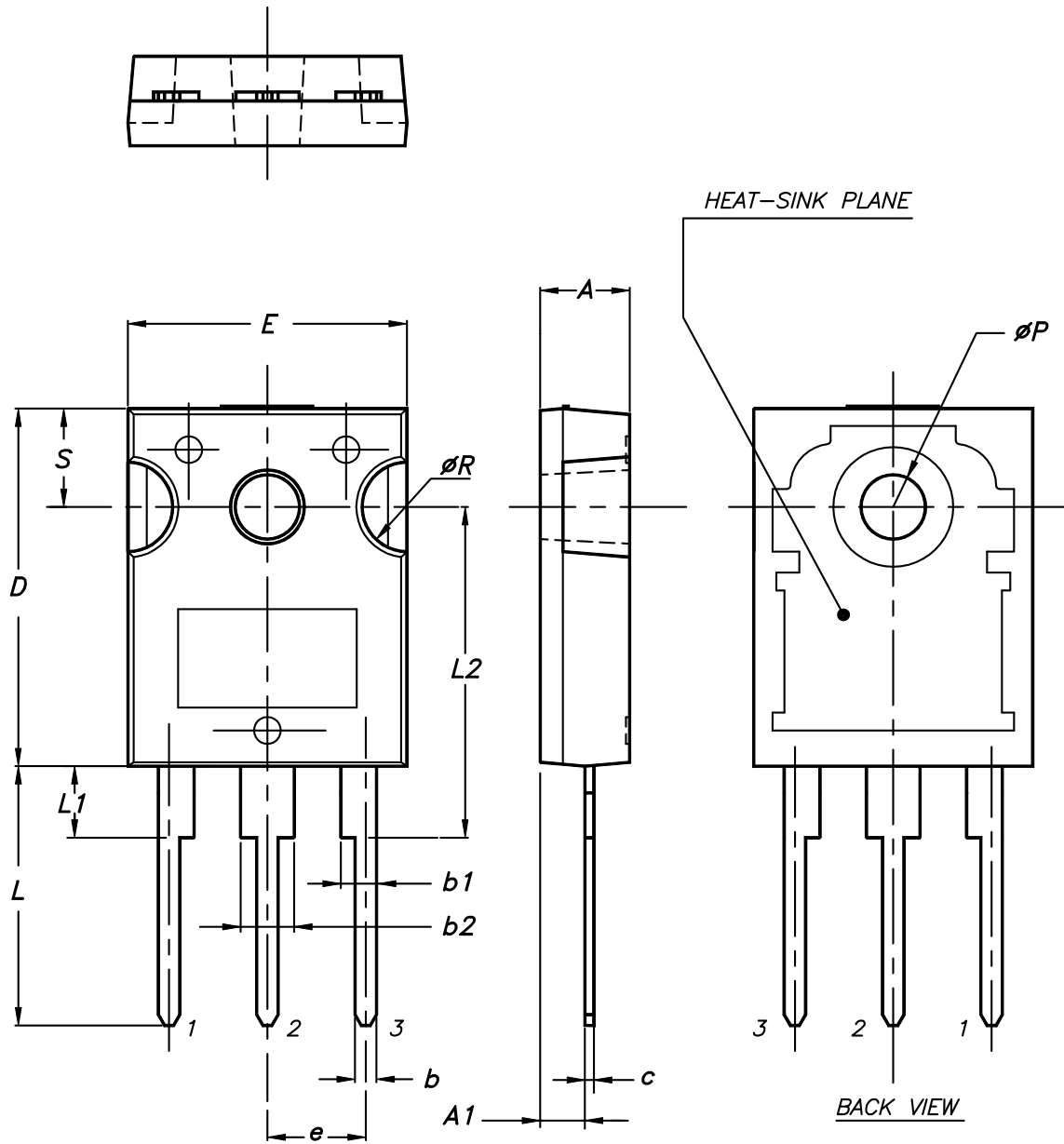
4.1 TO-247 package information

Figure 24. TO-247 package outline



0075325_9

Table 6. TO-247 package mechanical data

Dim.	mm		
	Min.	Typ.	Max.
A	4.85		5.15
A1	2.20		2.60
b	1.0		1.40
b1	2.0		2.40
b2	3.0		3.40
c	0.40		0.80
D	19.85		20.15
E	15.45		15.75
e	5.30	5.45	5.60
L	14.20		14.80
L1	3.70		4.30
L2		18.50	
ØP	3.55		3.65
ØR	4.50		5.50
S	5.30	5.50	5.70

Revision history

Table 7. Document revision history

Date	Revision	Changes
04-Jun-2013	1	First release
06-Feb-2014	2	Updated <i>Figure 1: Internal schematic diagram</i> . Updated title, features and description in cover page. Minor text changes.
21-Jun-2017	3	Modified title, features and internal schematic on cover page. Modified <i>Table 3. Static characteristics</i> and <i>Table 5. IGBT switching characteristics (inductive load)</i> . Updated Package information. Minor text changes.
17-Sep-2018	4	Updated Section 2.1 Electrical characteristics (curves) . Minor text changes

Contents

1	Electrical ratings	2
2	Electrical characteristics	3
2.1	Electrical characteristics (curves)	5
3	Test circuits	9
4	Package information	10
4.1	TO-247 package information	10
	Revision history	13

IMPORTANT NOTICE – PLEASE READ CAREFULLY

STMicroelectronics NV and its subsidiaries (“ST”) reserve the right to make changes, corrections, enhancements, modifications, and improvements to ST products and/or to this document at any time without notice. Purchasers should obtain the latest relevant information on ST products before placing orders. ST products are sold pursuant to ST’s terms and conditions of sale in place at the time of order acknowledgement.

Purchasers are solely responsible for the choice, selection, and use of ST products and ST assumes no liability for application assistance or the design of Purchasers’ products.

No license, express or implied, to any intellectual property right is granted by ST herein.

Resale of ST products with provisions different from the information set forth herein shall void any warranty granted by ST for such product.

ST and the ST logo are trademarks of ST. All other product or service names are the property of their respective owners.

Information in this document supersedes and replaces information previously supplied in any prior versions of this document.

© 2018 STMicroelectronics – All rights reserved

Mouser Electronics

Authorized Distributor

Click to View Pricing, Inventory, Delivery & Lifecycle Information:

[STMicroelectronics:](#)

[STGW60V60F](#)