

Product features:

1. International Universal input voltage: 85-264V AC or 110-370V DC.
2. High efficiency, high power density, high accuracy of output voltage.
3. High isolation between input and output.
4. Overcurrent protection, short circuit protection and temperature protection.
5. The output has built-in filter and can be used without external filter circuit.
6. 2 Years Quality Assurance

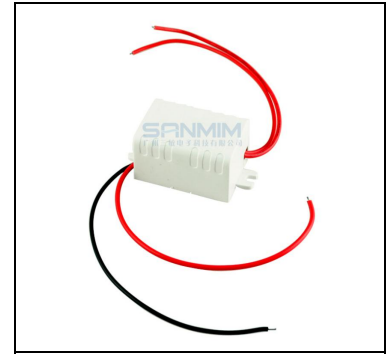

Item	Condition	Common models of this series we have (we can customize any products with different output voltage and current or other requirements according to customer's requirements)					
		PK03A-03	PK03A-05	PK03A-09	PK03A-12	PK03A-15	PK03A-24

1、 Input Features

AC Input(VAC)	85-264					
DC Input(VDC)	110-370					
Frequency Range(Hz)	47-63					
Input Current(A)	0.3/115VAC 0.15/230VAC					
Surge current(A)	Cold Boot: 10A/230VAC					
Efficiency(TYP.)	62%	69%	75%	75%	75%	75%
Stand-by power consumption(mW)	≤150mW/220VAC					

2、 Output Features

Output Voltage(VDC)	3.3V	5V	9V	12V	15V	24V
Output voltage accuracy	±1%					
Rated current(ADC)	0.8A	0.6A	0.4A	0.3A	0.2A	0.15A
Rated power (W)	2.6W	3W	3W	3W	3W	3W
Ripple&Noise (mvp-p)	Rated input voltage, 20MHz bandwidth	≤400mV		≤260mV		
Linear adjustment rate	Full-load	±1%				
Load regulation	10-100% Load	±3%				
Startup and rise time	Full-load	2000ms, 30ms/115VAC 1000ms, 30ms/230VAC				
Retention time(ms)	Full-load	16ms/115VAC 50ms/230VAC				
Overload protection	Rated input voltage	115%-150% of the rated output power(Overload Protection) Protection mode: hiccup mode, auto-response after removal of abnormal loading condition				
Short-circuit protection	Rated input voltage	Automatic recovery after long-term short circuit				
Over-current protection		≥1.1 Times I _o				
Start delay time(ms)	Vin: 230VAC	500ms				
Power-off protection time (ms)		20ms				

3、General Features

Working temperature(°C)	/	-30-70
Working humidity (RH)	/	20-90%, non-condensing
Temperature drift coefficient	/	±0.02%/°C
Storage temperature and humidity		-40~+85°C 10-95%RH
Switching frequency (KHz)		5-65 (Frequency conversion green energy-saving chip)
Isolation voltage (VAC)	Input-to-output, test lasted 60s, ≤ 5mA	2000
Insulation resistance(MΩ)	Input-to-output, 500VDC	100
Leakage current(mA)	500VDC	Input-to-output ≤1mA/RMS
MTBF	@25°C	215000h
Safety level	/	Adaptation: CLASS B
Vibration resistance	/	10—500Hz 2G 10 minutes/cycle. 60 minutes each for X, Y and Z.
Electro-magnetic compatibility	/	Adaptation: EN55022(CISPR22) Class B EN61000-3-2,-3
Remarks	<p>1. Except for special instructions, the parameters of this specification are measured at 230VAC input, rated load and 25°C.</p> <p>2. Measurement of ripple and noise: Using a 12" twisted pair, and the terminal has two capacitors, 0.1uF and 10uF in parallel. Measured at 20MHz bandwidth.</p> <p>3. Accuracy: Including errors, linear adjustment rate and load adjustment rate.</p> <p>4. The power supply should be regarded as part of the components in the system, and electro-magnetic compatibility related confirmation should be carried out with the terminal equipment.</p> <p>5. Reduced output is required under low input voltage. Please refer to the reduction graph.</p>	

>Curves Chart For Product Features

Load(%)

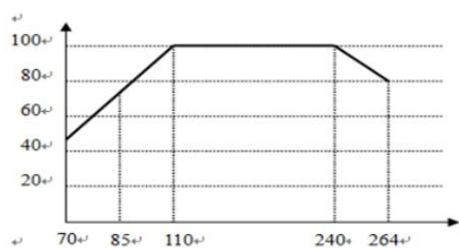

input Voltage(VAC)

Load(%)

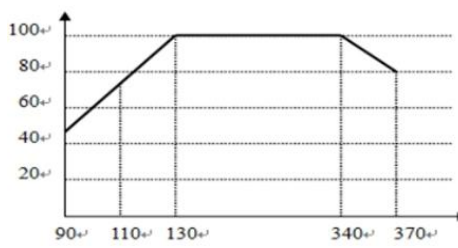

output Voltage(VAC)

Working Environment Temperature and Load Features

Output Power(%)

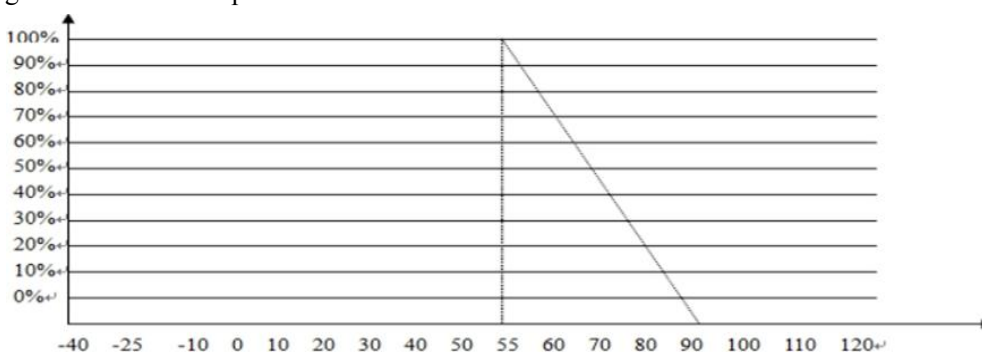

>1. Typical application circuit

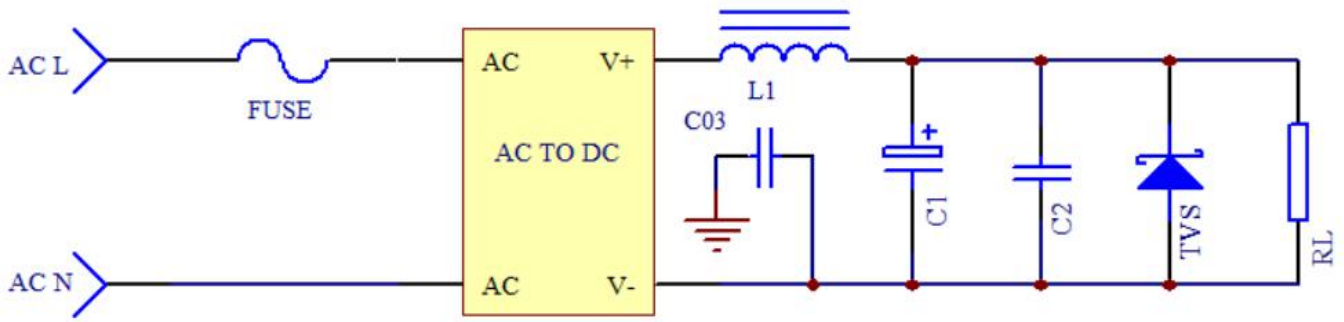

>Input Parts:

Original Bit Number/Recommended Device	Effects	Recommended values
FUSE	When the power supply is abnormal, the protection circuit is protected from damage.	0.5A/250VAC, Slow Break

>Output Parts:

Output Voltage	C1	C2	C03	L1	TVS
3.3V	680uF/10V	1uF/50V	Y2 Capacitance 1000pF/250VAC	Inductance 8uH-15uH, Copper wire diameter $\geq 0.45\text{mm}$	SMBJ5.0A
5V					SMBJ7.0A
9V	470uF/16V				SMBJ12A
12V	330uF/25V				SMBJ15A
15V					SMBJ18A
24V	220uF/35V				SMBJ28A

- Remarks:
- C1: Connecting/coupling filter electrolytic capacitors, high frequency and low resistance capacitors are recommended. Capacitance withstand voltage drop more than 75%, remove noise caused by connectors.
 - C2: Removing high frequency noise for Ceramic capacitors
 - C03: Y2 Safety capacitor to remove high-frequency noise from power grid or power supply.
 - TVS: It is recommended to protect the back-stage circuit when the power supply is abnormal.

>EMC Solution--Recommended Circuit

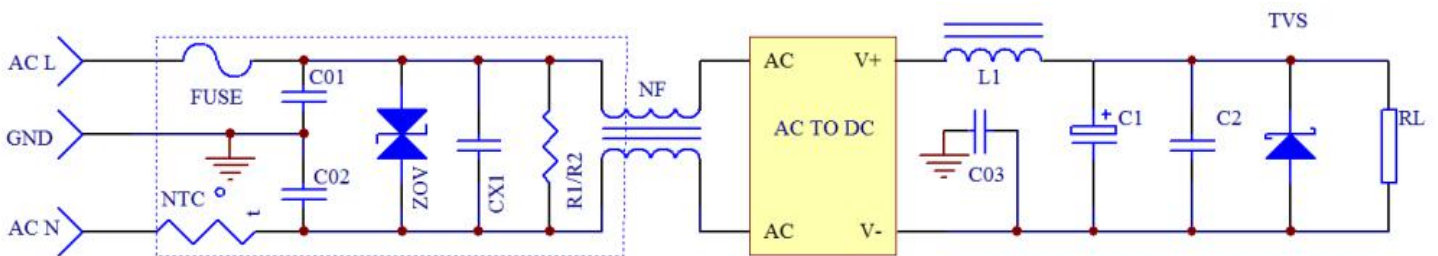

>Input Parts:

Original Bit Number/Recommended Device	Effects	Recommended values
FUSE	When the power supply is abnormal, the protection circuit is protected from damage.	0.5A/250VAC, Slow Fuse (Necessary Connection)
NTC: Thermistor	Inhibition of surge current, protection module is not damaged.	5D-7
ZOV: Varistor	Protection module is not damaged in lightning surge.	07D471K
CX1: X2 Capacitor	Suppression of differential mode interference.	0.22uF/275VAC
R1/R2: Discharge resistance		1MΩ 1/2W
C01,C02,C03: Y2 Capacitor	Common mode interference is suppressed to improve the anti-interference ability of equipment and the reliability of the system.	1000pF/250VAC
NF: Common mode inductor		10 mH -30 mH

>Product Packaging and Pin Definition Diagram

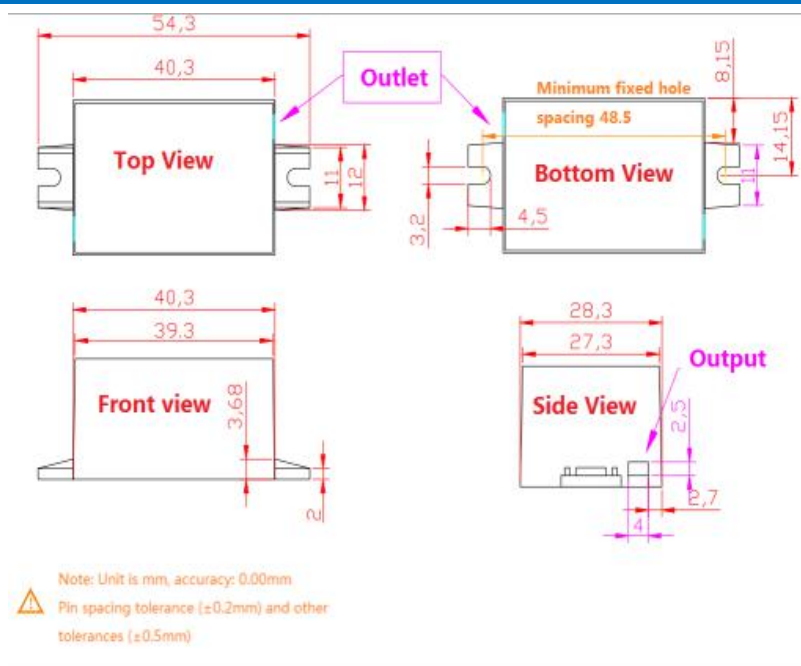

Product selection and Notes:

1. Please refer to the specifications in detail for selection and use, otherwise the reliability of power supply will not be guaranteed.
2. All parameters of this specification are measured according to the internal standards of our company.
3. It is suggested that the load power of the power supply should not exceed 80% of the rated power of the power supply.
4. With multi-output power supply, each output circuit must be loaded and used at the same time according to the corresponding ratio.
5. Our company can provide customized products.
6. We reserve the right to change specifications without prior notice.
7. For more product information, please contact us or log on our website: <https://www.sanmim.com>

>Contact Information

Guangzhou Sanmim Electronic Technology Co., Ltd.

Tel: 020-37720376 Phone: 13751801082

E-mail: indy@sanmim.com

Address: Building D, No. 8 Microthink Tank Industrial Park, Xianke Road No.1, Xiutang Village, Huadong Town, Huadu District, Guangzhou510890