

Features

- Push switch option standard
- Compact, rugged design
- High reliability
- Metal bushing/shaft
- Surface mount version



PEC11S Series - 12 mm SMD Incremental Encoder

Electrical Characteristics

Output	2-bit quadrature code
Closed Circuit Resistance	3 ohms maximum
Contact Rating	10 mA @ 5 VDC
Insulation Resistance	100 megohms @ 250 VDC
Dielectric Withstanding Voltage	
Sea Level	300 VAC minimum
Electrical Travel	Continuous
Contact Bounce (15 RPM)	2.0 ms maximum
RPM (Operating)	60 maximum

Environmental Characteristics

Operating Temperature Range	-40 °C to +70 °C (-40 °F to +158 °F)
Storage Temperature Range	-40 °C to +85 °C (-40 °F to +185 °F)
Operating Humidity	25 % to 85 % R.H.
Rotational Life	15,000 cycles minimum
Switch Life	20,000 cycles minimum
IP Rating	IP 40

Mechanical Characteristics

Mechanical Angle	360 ° continuous
Detent Torque	100 ±70 gf.cm (1.36 ±0.1 oz.-in.)
Shaft Push-Pull Strength	10 kg max.
Weight	5 gm (0.17 oz.) maximum
Terminals	Printed circuit board surface mount terminals
Soldering Condition	
Reflow Soldering	Sn95.5/Ag2.8/Cu0.7 solder with no-clean flux (see Solder Profiles for recommended time and temperature)
Hand Soldering	Not recommended
Hardware	No hardware supplied with this encoder

Switch Characteristics

Switch Type	Contact Push ON Momentary SPST
Power Rating (Resistive Load)	10 mA at 5 V DC
Switch Travel	
S (Standard)	0.5 ± 0.3 mm
H (High)	1.5 ± 0.5 mm
Switch Actuation Force	See How to Order
Contact Resistance	100 mΩ max.

How To Order

PEC11S - 9 2 20 F - S 0015

Model	PEC11S
Terminal Configuration	9 = Surface Mount Gull-wing Style
Detent Option	2 = 30 Detents
Shaft Length (see Product Dimensions - Shaft Styles for availability)	20 = 20.0 mm
9 = 9.5 mm	
13 = 13.5 mm (Knurled Shaft with "H" Switch Option Only)	
15 = 15.0 mm	
Shaft Style	F = Flatted, Metal
K = Knurled, Metal	
Switch Configuration (SPST)	S = 350 ± 100 gf
H = 400 ± 200 gf	
N = No Switch	
Resolution	0015 = 15 Pulses per 360 ° Rotation

Quadrature Output Table

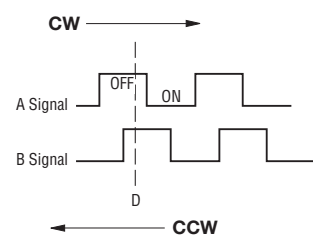

Switch Circuit

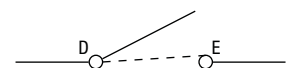

NOTE: D and E are dummy terminals on non-switch version.

*RoHS Directive 2002/95/EC Jan. 27, 2003 including annex and RoHS Recast 2011/65/EU June 8, 2011.

Specifications are subject to change without notice.

The device characteristics and parameters in this data sheet can and do vary in different applications and actual device performance may vary over time.

Users should verify actual device performance in their specific applications.

Applications

Level control, tuning and timer settings in:

- Audio-visual equipment
- Consumer electric appliances
- Radios
- Musical instrumentation
- Communications equipment

PEC11S Series - 12 mm SMD Incremental Encoder BOURNS®

Solder Profile

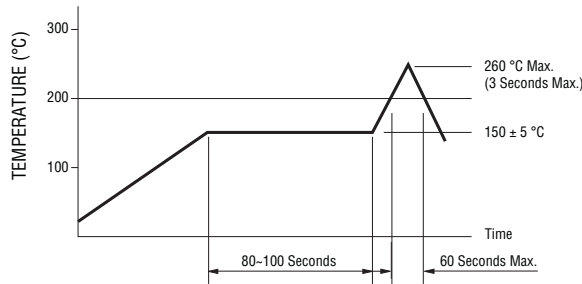

Processing Method: Reflow soldering with infrared heat or forced air convection (only once).

Notes:

1. No clean solder paste is recommended.
2. Aqueous wash is not recommended.
3. Use of water soluble soldering flux shall be avoided due to possible corrosion.
4. Multiple passes through the soldering process is not recommended.

Product Dimensions

Common Dimensions

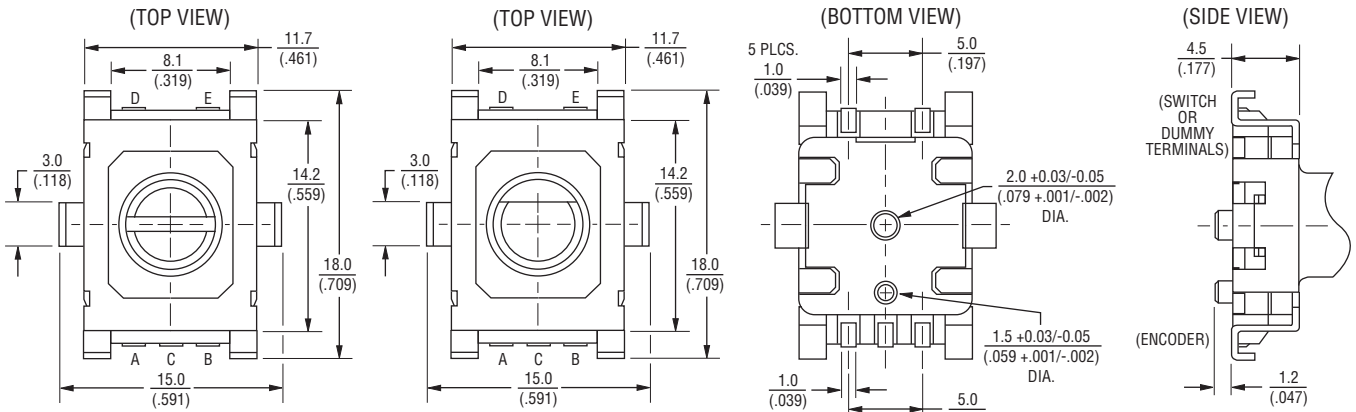

TOLERANCES (UNLESS OTHERWISE NOTED): $\frac{\leq 10}{\leq (.394)} = \frac{\pm 0.3}{\pm (.012)}$ $\frac{> 10}{> (.394)} = \frac{\pm 0.5}{\pm (.020)}$

Recommended PCB Layout

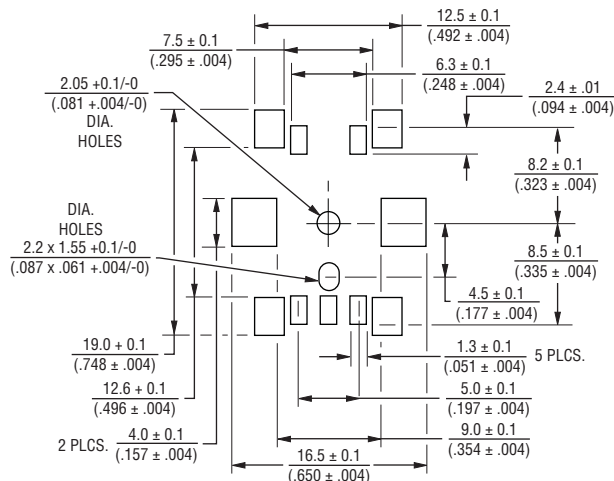

DIMENSIONS: $\frac{\text{MM}}{\text{(INCHES)}}$

Specifications are subject to change without notice.
The device characteristics and parameters in this data sheet can and do vary in different applications and actual device performance may vary over time.
Users should verify actual device performance in their specific applications.

PEC11S Series - 12 mm SMD Incremental Encoder



Product Dimensions - Shaft Styles

PEC11S without Switch

KNURLED SHAFT

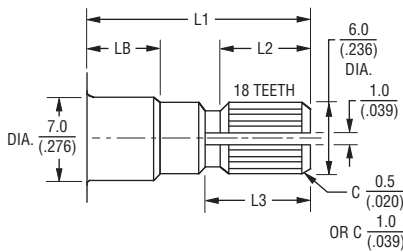

L1	LB	L2	L3
15 (.591)	5 (.197)	8 (.315)	7 (.276)
20 (.787)	7 (.276)	10 (.394)	11 (.433)

DIMENSIONS: $\frac{\text{MM}}{\text{(INCHES)}}$

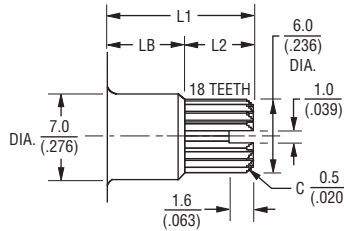

L1	LB	L2
9.5 (.374)	5 (.197)	4.5 (.177)

FLATTED SHAFT

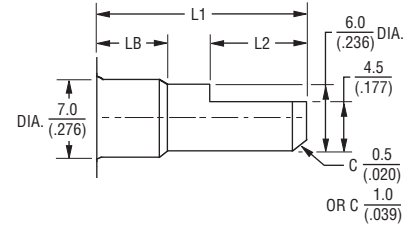

L1	LB	L2
15 (.591)	5 (.197)	7 (.276)
20 (.787)	7 (.276)	12 (.472)

PEC11S with 0.5 mm Switch Travel

KNURLED SHAFT

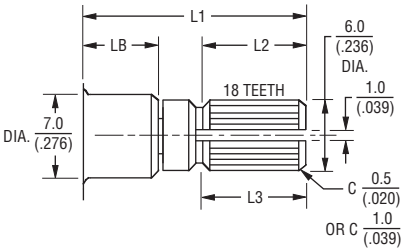

L1	LB	L2	L3
15 (.591)	5 (.197)	7 (.276)	9 (.354)
20 (.787)	7 (.276)	9 (.354)	10 (.394)

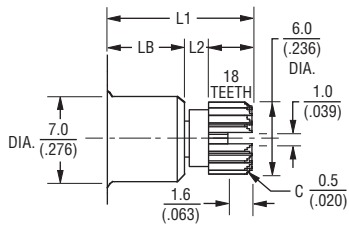

L1	LB	L2
9.5 (.374)	5 (.197)	2.9 (.114)
13.5 (.531)	5 (.197)	6.9 (.272)

FLATTED SHAFT

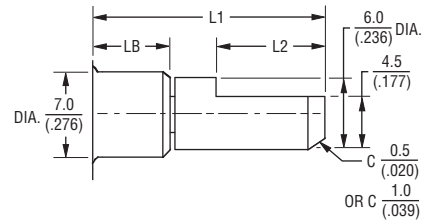

L1	LB	L2
9.5 (.374)	5 (.197)	3 (.118)
15 (.591)	5 (.197)	7 (.276)
20 (.787)	7 (.276)	10 (.394)

PEC11S with 1.5 mm Switch Travel

KNURLED SHAFT

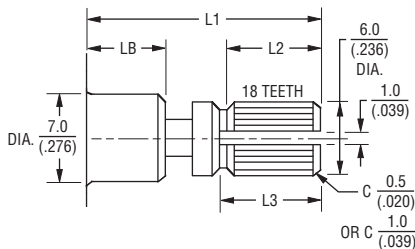

L1	LB	L2	L3
15 (.591)	5 (.197)	6 (.236)	6.5 (.256)
20 (.787)	7 (.276)	8 (.315)	9 (.354)

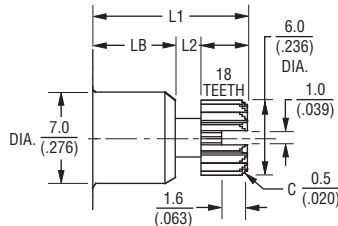

L1	LB	L2
9.5 (.374)	5 (.197)	2.9 (.114)
13.5 (.531)	5 (.197)	6.9 (.272)

FLATTED SHAFT

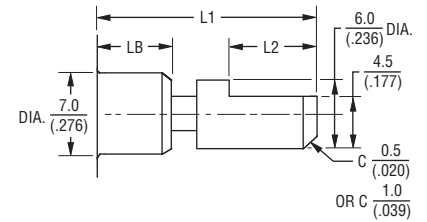

L1	LB	L2
15 (.591)	5 (.197)	7 (.276)
20 (.787)	7 (.276)	10 (.394)

REV. 03/13

Specifications are subject to change without notice.

The device characteristics and parameters in this data sheet can and do vary in different applications and actual device performance may vary over time.

Users should verify actual device performance in their specific applications.

Mouser Electronics

Authorized Distributor

Click to View Pricing, Inventory, Delivery & Lifecycle Information:

Bourns:

[PEC11S-9213K-S0015](#) [PEC11S-9215K-H0015](#) [PEC11S-9215K-N0015](#) [PEC11S-9220F-S0015](#) [PEC11S-9220K-S0015](#) [PEC11S-929K-H0015](#) [PEC11S-929K-N0015](#) [PEC11S-929K-S0015](#) [PEC11S-9213F-H0015](#) [PEC11S-9215F-N0015](#) [PEC11S-9213K-H0015](#) [PEC11S-929F-S0015](#) [PEC11S-9215K-S0015](#)