



Document Name	Document No.	Ver	Date	Page
LP384765 Specification	ZJQM-RD-SPC-A0382	0.0	2014-11-5	1/7

EEMB CO., LTD

Polymer Li-ion Battery

Specification

Model: LP384765

Capacity: 1150mAh

Prepared	Checked	Approved

Customer:

Customer Approval (Customer confirmation) :

Customer Approval (Customer confirmation) :		
Signature	Checked	Approved

Address: Room ABCD,25/F, Block A, Fortune Plaza, NO.7060 Shennan Road Shenzhen, China

Postal code: 518040

Phone: 0086-755-83022275

FAX: 0086-755-83021966

<http://www.eemb.com>

Document Name	Document No.	Ver	Date	Page
LP384765 Specification	ZJQM-RD-SPC-A0382	0.0	2014-11-5	2/7

Catalog

Chapter	Content	Page
0	Catalog.....	2
1	Scope.....	3
2	Product Basic Characteristics.....	3
2.1	Model.....	3
2.2	Capacity.....	3
2.3	Nominal Voltage.....	3
2.4	Weight.....	3
2.5	Internal Impedance.....	3
2.6	Dimension.....	3
2.7	Charge.....	3
2.8	Discharge.....	3
2.9	Operation Temperature.....	3
2.10	Storage Temperature.....	3
2.11	Storage Relative Humidity.....	3
3	Shape and Dimensions.....	3
4	Appearance.....	3
5	Specification.....	4
5.1	Electrical Characteristics.....	4
5.1.1	1C ₅ A rate discharge capacity.....	4
5.1.2	High temp. discharge capacity.....	4
5.1.3	Low temp. discharge capacity.....	4
5.1.4	Cycle Life.....	4
5.1.5	Capacity Retention.....	4
5.2	Acclimatization Characteristics.....	4
5.2.1	High Temp. and High Humidity	4
5.2.2	Vibration	4
5.2.3	Drop.....	4
5.2.4	Low-pressure.....	4
5.3	Safety Characteristics.....	5
5.3.1	Overcharge.....	5
5.3.2	Short-Circuit.....	5
5.3.3	Heating.....	5
5.3.4	Temperature Cycle.....	5
6	Battery Shipment Voltage.....	5
7	Shelf Life.....	5
8	Matters Needing Attention.....	5-7

Document Name	Document No.	Ver	Date	Page
LP384765 Specification	ZJQM-RD-SPC-A0382	0.0	2014-11-5	3/7

1. Scope

This product specification defines the requirements of the rechargeable polymer lithium-ion battery supplied to the customer by EEMB Co., Ltd.

2. Product Basic Characteristics

No.	Item	Characteristics	Remark	
2.1	Model	LP384765		
2.2	Capacity	Nominal Capacity	1150 mAh	0.2C ₅ A
		Minimum	1050 mAh	0.2C ₅ A
2.3	Nominal Voltage	3.7 V		
2.4	Weight	Approx.23 g		
2.5	Internal Impedance	≤ 80 mΩ	AC 1KHz(50% charge)	
2.6	Dimension	Length	≤ 66 mm	
		Width	≤ 47.5 mm	
		Thickness	≤ 4.1 mm	
2.7	Charge	Maximum Current	1150 mA	1.0C ₅ A (CC&CV)
		Limited Voltage	4.200±0.020 V	
		End-of Current	23 mA	
2.8	Discharge	Maximum Current	2300 mA	2.0C ₅ A
		End Voltage	2.750±0.005 V	
2.9	Operation Temperature	Charge	0 ~ 45 °C	
		Discharge	-20 ~ +60 °C	
2.10	Storage Temperature	1 month	-20 ~ +60 °C	
		3 month	-20 ~ +45 °C	
		12 month	-20 ~ +25 °C	
2.11	Storage Relative Humidity	65±20 %		

3. Shape and Dimensions (Unit: mm)

Item	Specification
T	Max4.1
W	Max47.5
L	Max66
L1	Max67
L2	10±1
M	30±1
N	4±0.5

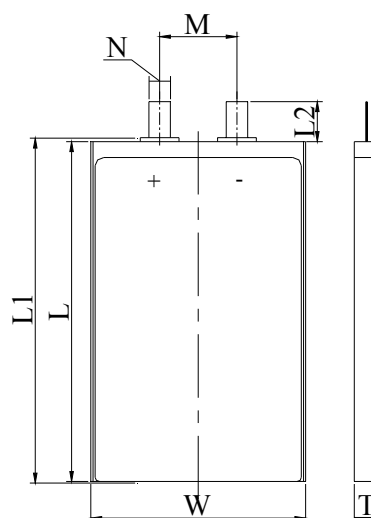

Document Name	Document No.	Ver	Date	Page
LP384765 Specification	ZJQM-RD-SPC-A0382	0.0	2014-11-5	4/7

4. Appearance

It shall be free from any defects such as remarkable scratches, breaks, cracks, discoloration, leakage, or middle deformation.

5. Specification

5.1 Electrical Characteristics

No.	Item	Criteria	Test Instructions
5.1.1	1C ₅ A rate discharge capacity	Discharge Capacity ≥ Minimum Capacity	Full charge at 20±5°C, rest for 30 min, then discharge at the same temperature with 1.0C ₅ A to 2.75V.
5.1.2	High temp. discharge capacity	Discharge Time ≥ 54min	Full charge at 20±5°C, store at 55±2°C for 2h, then discharge at the same temperature with 1.0C ₅ A to 2.75V.
5.1.3	Low temp. discharge capacity	Discharge Time ≥ 4.25h	Full charge at 20±5°C, store at -10°C±2°C for 16h~24h, then discharge at the same temperature with 0.2C ₅ A to 2.75V
5.1.4	Cycle Life	≥ 500 Cycles (0.5C ₅ A) ≥ 800 Cycles (0.2C ₅ A)	After full charge, rest for 10 min, then discharge at constant current to 2.75V, rest for 10 minutes. Repeat above steps until the two consecutive cycles of discharge time is less than the regulated time. (500 cycles ≥ 96min, 800 cycles ≥ 240min)
5.1.5	Capacity Retention	Discharge Time ≥ 4.5 h	After full charge, store at 20±5°C for 28 days. Then discharge with 0.2C ₅ A to 2.75V

5.2 Acclimatization Characteristics

No.	Item	Criteria	Test Instructions
5.2.1	High Temp. and High Humidity	No deformation, no rust, no fire or explosion; Discharge time ≥ 36min	After full charge, store at 40°C±2°C (90%~95%RH) for 48h. After test, place at 20°C±5°C for 2h and then discharge with 1C ₅ A to end-voltage
5.2.2	Vibration	No deformation, leakage, no fire or explosion; Battery Voltage ≥ 3.6V	Batteries are vibrated 30 min in three mutually perpendicular directions with amplitude of 0.38mm (10~30Hz) or 0.19mm (30~55Hz) and the scanning rate of 1oct per min
5.2.3	Drop	No leakage, no fire or explosion; Discharge Time ≥ 51 min	Batteries are dropped onto a hard board with the thickness of 18~20mm from at least 1meter height. Drop the batteries from six different directions and discharge them at 1C ₅ A to end-voltage.
5.2.4	Low-pressure	No leakage, no fire or explosion	Put the batteries in a sealed vacuum and reduce internal pressure gradually to lower than 11.6 kpa. Keep for 6h

5.3 Safety Characteristics

No.	Item	Criteria	Test Instructions
5.3.1	Overcharge	No fire or explosion	Put the batteries with thermocouple into the ventilation cabinet. Connect the polarities to constant voltage and adjust the current to $3C_5A$, voltage to 4.8V. Charged the cells at $3C_5A$ current $20\pm 5^\circ C$ with a voltage limit of 4.8V and Current approach 0 A.
5.3.2	Short-Circuit	No fire or explosion; The maximum Temperature: $150^\circ C$	Put the batteries with thermocouple into the ventilation cabinet. Batteries are short-circuited by connecting the positive and negative terminals for 1h with a resistance load of $100m\Omega$. Watch the changes of temperature. Test the temperature of the batteries until it drops to $10^\circ C$.
5.3.3	Heating	No fire or explosion	Cell is heated in a circulating air oven at a rate of $(5\pm 2)^\circ C$ per minute to $130\pm 2^\circ C$, and then placed for 30 minutes at $130\pm 2^\circ C$
5.3.4	Temperature cycle	No leakage, no fire or explosion	After full charge, place the battery in the temperature control box of $20\pm 5^\circ C$, do the following steps: (1)Put the battery into test chamber of $75^\circ C\pm 2^\circ C$ and keep for 6h. (2)Lower the temperature to $-40\pm 2^\circ C$ and keep for 6h (3)Temperature conversion time is no longer than 30 min (4)Repeat the above three steps for 10 cycles.

Note: Unless otherwise specified, all tests stated in this specification are conducted at the following conditions:
Temp. : $20\pm 5^\circ C$; Relative Humidity: 25%~85%.

6. Battery shipment voltage: 3.83~3.9V

7. Shelf Life: One year warranty

8. Matters needing attention

Strictly observes the following needing attention. EEMB will not be responsible for any accident occurred by handling outside of the precautions in this specification.

! Danger

- Strictly prohibits heat or throw cell into fire.
- Strictly prohibits throw and wet cell in liquid such as water、gasoline or drink etc.
- Strictly prohibits use leave cell close to fire or inside of a car where temperature may be above $60^\circ C$.
Also do not charge / discharge in such conditions.
- Strictly prohibits put batteries in your pockets or a bag together with metal objects such as necklaces. Hairpins, coins, or screws. Do not store or transportation batteries with such objects.
- Strictly prohibits short circuit the (+) and (-) terminals with other metals.
- Do not place Cell in a device with the (+) and (-) in the wrong way around.
- Strictly prohibits pierce Cell with a sharp object such as a needle.
- Strictly prohibits disassemble or modify the cell.

Document Name	Document No.	Ver	Date	Page
LP384765 Specification	ZJQM-RD-SPC-A0382	0.0	2014-11-5	6/7

- Strictly prohibits welding a cell directly.
- Do not use a Cell with serious scar or deformation.
- Thoroughly read the user's manual before use, inaccurate handling of lithium ion rechargeable cell may cause leakage, heat, smoke, an explosion, or fire, capacity decreasing.

! Warning

- Strictly prohibits put cell into a microwave oven, dryer, or high-pressure container.
- Strictly prohibits use cell with dry cells and other primary batteries, or new and old battery or batteries of a different package, type, or brand.
- Stop charging the Cell if charging is not completed within the specified time.
- Stop using the Cell if abnormal heat, odor, discoloration, deformation or abnormal condition is detected during use, charge, or storage.
- Keep away from fire immediately when leakage or foul odor is detected.
- If liquid leaks onto your skin or clothes, wash well with fresh water immediately.
- If liquid leaking from the Cell gets into your eyes, do not rub your eyes. Wash them well with clean edible oil and go to see a doctor immediately.

! Caution

- Before using the Cell, be sure to read the user's manual and cautions on handling thoroughly.
- Charging with specific charger according to product specification. Charge with CC/CV method. Strictly prohibits reversed charging. Connect cell reverse will not charge the cell. At the same time, it will reduce the charge-discharge characteristics and safety characteristics; this will lead to product heat and leakage.
- Store batteries out of reach of children so that they are not accidentally swallowed.
- If younger children use the Cell, their guardians should explain the proper handling.
- Before using the Cell, be sure to read the user's manual and cautions on handling thoroughly.
- Batteries have life cycles. If the time that the Cell powers equipment becomes much shorter than usual, the Cell life is at an end. Replace the Cell with a new same one.
- When not using Cell for an extended period, remove it from the equipment and store in a place with low humidity and low temperature.
- While the Cell pack is charged, used and stored, keep it away from objects or materials with static electric charges.
- If the terminals of the Cell become dirty, wipe with a dry clothe before using the Cell.
- Storage the cell in storage temperature range as the specifications. After full discharged, we suggest that charging to 3.7~4.0V with no using for a long time.
- Do not exceed these ranges of the following temperature ranges:
 - Charge temperature range : 0°C to 45°C;
 - Discharge temperature range : -20°C to 60°C.
 - Store less than 1 month : -20°C - +60°C
 - Store less than 3 months : -20°C - +45°C
 - Store less than 1 year : -20°C - +25°C



Document Name	Document No.	Ver	Date	Page
LP384765 Specification	ZJQM-RD-SPC-A0382	0.0	2014-11-5	7/7

! Special Notice

Keep the cell in **50% charged state** during long period storage. We recommend to charge the battery up to 50% of the total capacity every 3 months after receipt of the battery and maintain the voltage 3.7~4.0V. And store the battery in cool and dry place.