

Micro Switch Series

KLS7-KW4-3Z Micro Switch Series

Features

- Small contact clearance, high sensitivity
- Snap action, high precision and high repeat accuracy
- Flexible operating travel, wide range of operating force
- Wide variety of terminal types
- Wide variety of actuator forms
- Adopt flame-retarded and fiber enhanced thermoplastics
- Long life cycles, high reliability
- Various approvals

Application

- Widely applied in home appliances, medical devices, office facility, instrument and apparatus, electric motion tools, packing machinery, auto electronics etc.
- Examples: vending machines, gaming machines, coffee machines, dishwashers, dryers, washing machines, microwave ovens, Central water heating, vacuum cleaners, water pump, projecting apparatus, industrial automations etc.



Specifications

Items	Value
Operating speed	0.1mm~1m/S
Operating Frequency	Mechanical 60cycles/min;
	Electrical 25cycles/min
Insulation resistance	≥100MΩ (DC500V)
Contact resistance	≤30mΩ (Initial value)
Test voltage	Between terminals of same polarity AC1500V 50/60HZ
	Between current-carrying metal parts and ground (case) AC3750V 50/60HZ
Vibration resistance	10~55 HZ 1.5mm Double amplitude
Shock resistance	Destruction: OF>0.5N: 1000m/S2 (approx. 100G) Max OF≤0.5N: 400m/S2 (approx. 40G) Max
	Malfunction: OF>0.5N: 200m/S2 (approx. 20G) Max OF≤0.5N: 100m/S2 (approx. 10G) Max
Life expectancy	Mechanical ≥2000000cycles
	Electrical ≥50000cycles
Degree of protection against electric	Class I /Class II
PTI	175
Approvals	UL CUL VDE TUV CE DEMKO CQC

Micro Switch Series

KLS7-KW4-3Z Micro Switch Series

ORDER INFORMATION

VII

KLS7-KW4-3Z- X X X X X X X - X

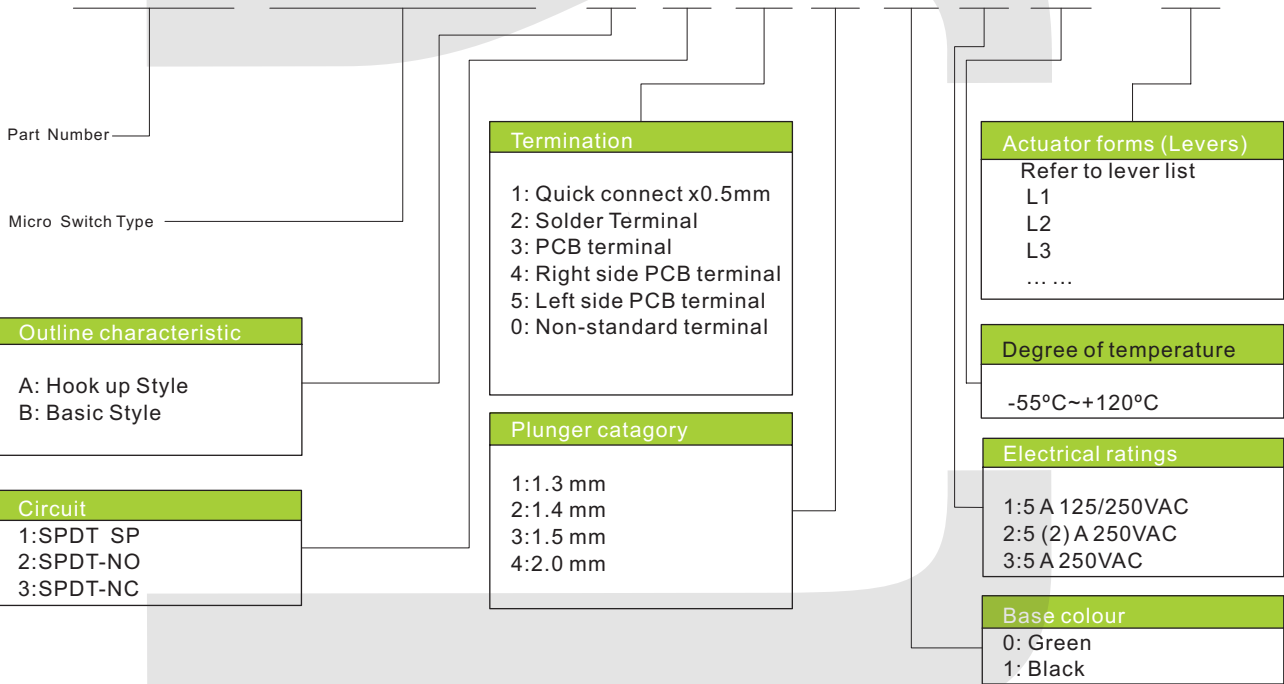

Outline Characteristic

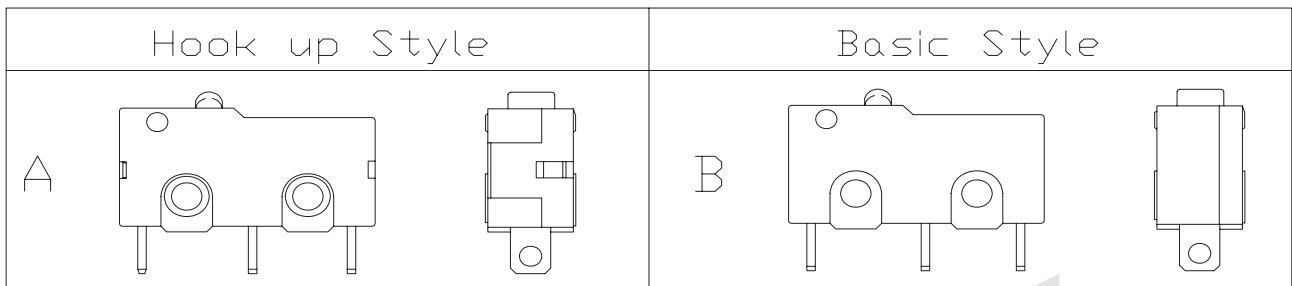

Circuit Illustration

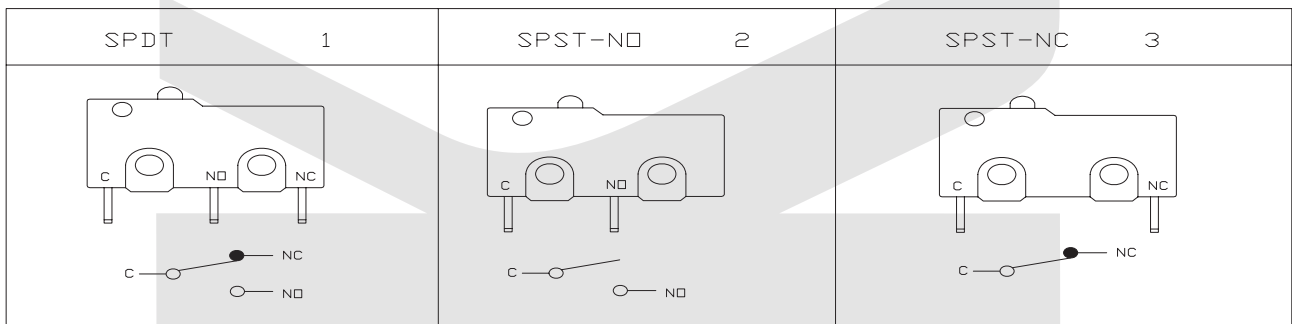

Micro Switch Series

KLS7-KW4-3Z Micro Switch Series

Mounting Hole Dimensions

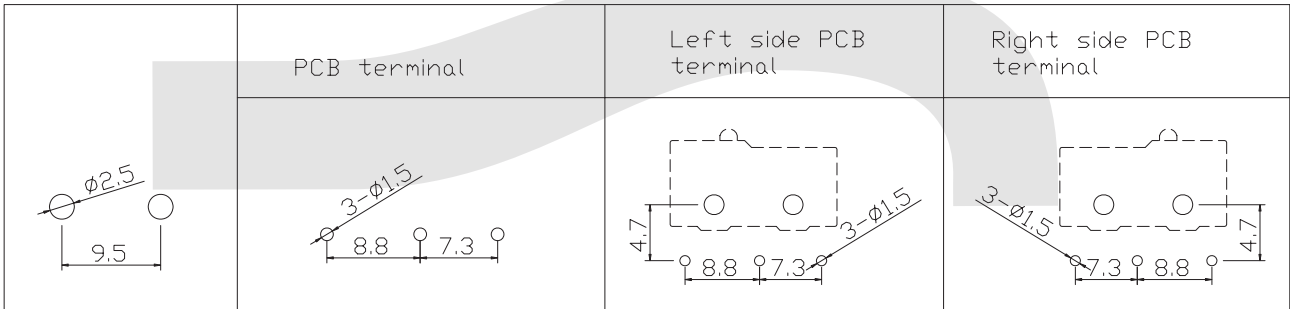

Terminal dimensions

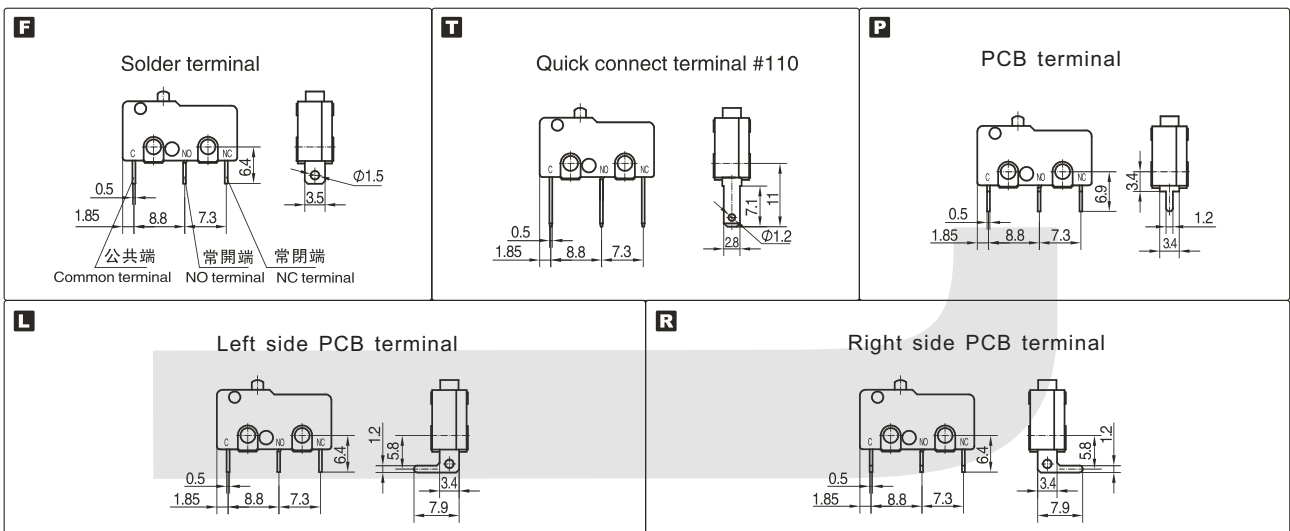



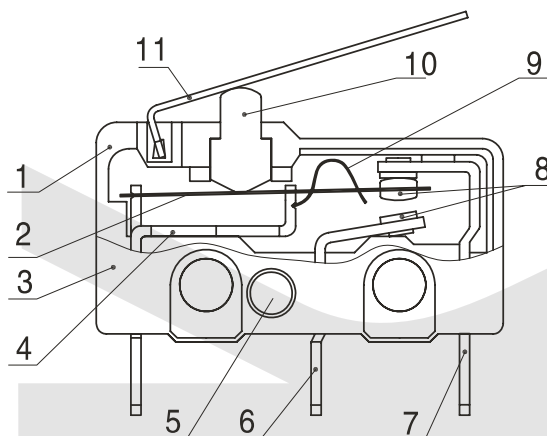





Internal configuration drawing

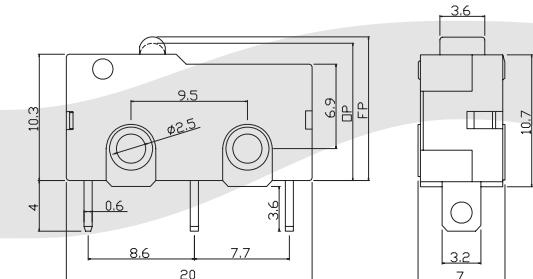

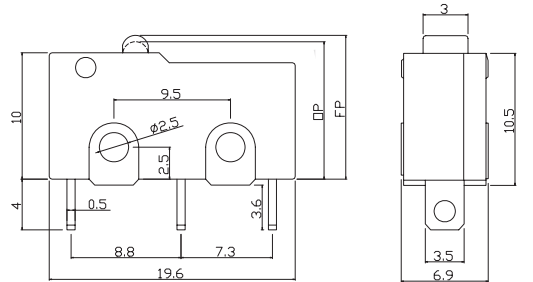
- 1 Case
- 2 Moving piece
- 3 Cover
- 4 Support
- 5 Rivet
- 6 NO terminal
- 7 NC terminal
- 8 Contact
- 9 Spring
- 10 Plunger
- 11 Moving arm(Lever)

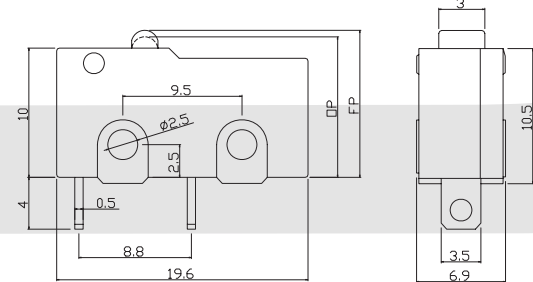
Micro Switch Series

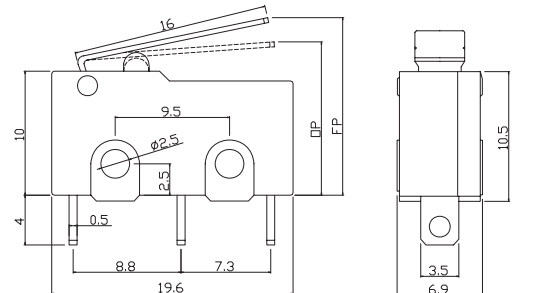
KLS7-KW4-3Z Micro Switch Series

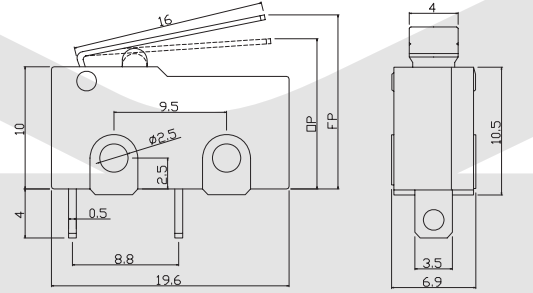
 KLS7-KW4-3Z-A122013L		<table border="1"> <tr><td>Model</td><td>KLS7-KW4-3Z-A122013L</td></tr> <tr><td>DF (N)</td><td>0.2~3.0</td></tr> <tr><td>MD Max(mm)</td><td>0.2</td></tr> <tr><td>PT Max(mm)</td><td>12.2</td></tr> <tr><td>DP Min(mm)</td><td>11.0</td></tr> </table>	Model	KLS7-KW4-3Z-A122013L	DF (N)	0.2~3.0	MD Max(mm)	0.2	PT Max(mm)	12.2	DP Min(mm)	11.0
Model	KLS7-KW4-3Z-A122013L											
DF (N)	0.2~3.0											
MD Max(mm)	0.2											
PT Max(mm)	12.2											
DP Min(mm)	11.0											
 KLS7-KW4-3Z-B122013L		<table border="1"> <tr><td>Model</td><td>KLS7-KW4-3Z-B122013L</td></tr> <tr><td>DF (N)</td><td>0.2~3.0</td></tr> <tr><td>MD Max(mm)</td><td>0.2</td></tr> <tr><td>PT Max(mm)</td><td>12.2</td></tr> <tr><td>DP Min(mm)</td><td>11.0</td></tr> </table>	Model	KLS7-KW4-3Z-B122013L	DF (N)	0.2~3.0	MD Max(mm)	0.2	PT Max(mm)	12.2	DP Min(mm)	11.0
Model	KLS7-KW4-3Z-B122013L											
DF (N)	0.2~3.0											
MD Max(mm)	0.2											
PT Max(mm)	12.2											
DP Min(mm)	11.0											
 KLS7-KW4-3Z-B222013L		<table border="1"> <tr><td>Model</td><td>KLS7-KW4-3Z-B222013L</td></tr> <tr><td>DF (N)</td><td>0.2~3.0</td></tr> <tr><td>MD Max(mm)</td><td>0.2</td></tr> <tr><td>PT Max(mm)</td><td>12.2</td></tr> <tr><td>DP Min(mm)</td><td>11.0</td></tr> </table>	Model	KLS7-KW4-3Z-B222013L	DF (N)	0.2~3.0	MD Max(mm)	0.2	PT Max(mm)	12.2	DP Min(mm)	11.0
Model	KLS7-KW4-3Z-B222013L											
DF (N)	0.2~3.0											
MD Max(mm)	0.2											
PT Max(mm)	12.2											
DP Min(mm)	11.0											
 KLS7-KW4-3Z-B122013L1		<table border="1"> <tr><td>Model</td><td>KLS7-KW4-3Z-B122013L1</td></tr> <tr><td>DF (N)</td><td>0.2~3.0</td></tr> <tr><td>MD Max(mm)</td><td>1.2</td></tr> <tr><td>PT Max(mm)</td><td>14.5</td></tr> <tr><td>DP Min(mm)</td><td>10.5</td></tr> </table>	Model	KLS7-KW4-3Z-B122013L1	DF (N)	0.2~3.0	MD Max(mm)	1.2	PT Max(mm)	14.5	DP Min(mm)	10.5
Model	KLS7-KW4-3Z-B122013L1											
DF (N)	0.2~3.0											
MD Max(mm)	1.2											
PT Max(mm)	14.5											
DP Min(mm)	10.5											
 KLS7-KW4-3Z-B222013L1		<table border="1"> <tr><td>Model</td><td>KLS7-KW4-3Z-B222013L1</td></tr> <tr><td>DF (N)</td><td>0.2~3.0</td></tr> <tr><td>MD Max(mm)</td><td>1.2</td></tr> <tr><td>PT Max(mm)</td><td>14.5</td></tr> <tr><td>DP Min(mm)</td><td>10.5</td></tr> </table>	Model	KLS7-KW4-3Z-B222013L1	DF (N)	0.2~3.0	MD Max(mm)	1.2	PT Max(mm)	14.5	DP Min(mm)	10.5
Model	KLS7-KW4-3Z-B222013L1											
DF (N)	0.2~3.0											
MD Max(mm)	1.2											
PT Max(mm)	14.5											
DP Min(mm)	10.5											

Micro Switch Series

KLS7-KW4-3Z Micro Switch Series



KLS7-KW4-3Z-B122013L2

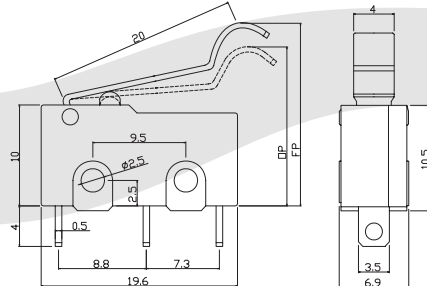

Model	KLS7-KW4-3Z-B122013L2
DF (N)	0.2~3.0
MD Max(mm)	1.2
PT Max(mm)	17.0
DP Min(mm)	13.0



KLS7-KW4-3Z-B222013L2

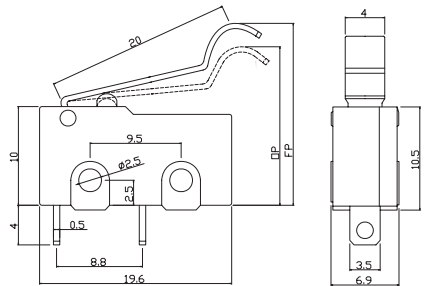

Model	KLS7-KW4-3Z-B222013L2
DF (N)	0.2~3.0
MD Max(mm)	1.2
PT Max(mm)	17.0
DP Min(mm)	13.0



KLS7-KW4-3Z-B132013L

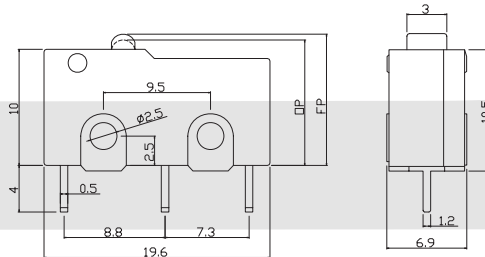

Model	KLS7-KW4-3Z-B132013L
DF (N)	0.2~3.0
MD Max(mm)	0.2
PT Max(mm)	12.0
DP Min(mm)	11.0



KLS7-KW4-3Z-B232013L

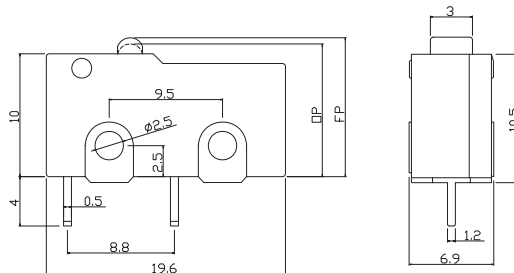

Model	KLS7-KW4-3Z-B232013L
DF (N)	0.2~3.0
MD Max(mm)	0.2
PT Max(mm)	12.0
DP Min(mm)	11.0



KLS7-KW4-3Z-B122013L3

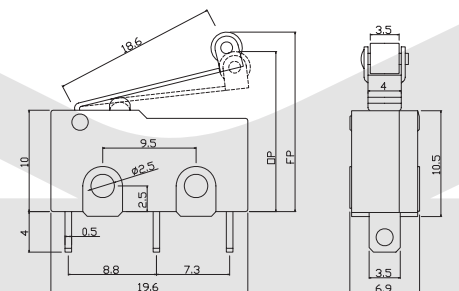

Model	KLS7-KW4-3Z-B122013L3
DF (N)	0.2~3.0
MD Max(mm)	1.2
PT Max(mm)	19.5
DP Min(mm)	16.0

Micro Switch Series

KLS7-KW4-3Z Micro Switch Series

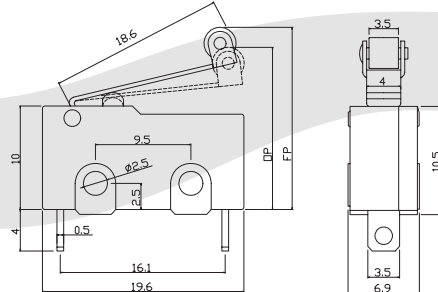
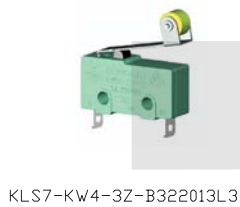

Model	KLS7-KW4-3Z-B322013L3
DF (N)	0.2~3.0
MD Max(mm)	1.2
PT Max(mm)	19.5
DP Min(mm)	16.0

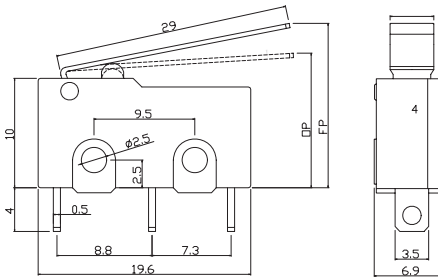

Model	KLS7-KW4-3Z-B122013L4
DF (N)	0.2~3.0
MD Max(mm)	1.5
PT Max(mm)	18.0
DP Min(mm)	14.5

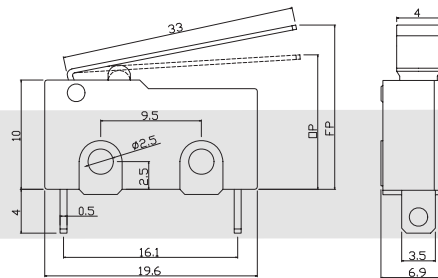

Model	KLS7-KW4-3Z-B322013L4
DF (N)	0.2~3.0
MD Max(mm)	1.5
PT Max(mm)	18.0
DP Min(mm)	14.5

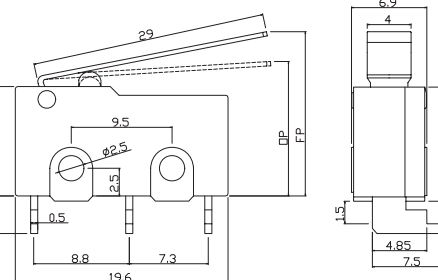

Model	KLS7-KW4-3Z-B152013L4
DF (N)	0.2~3.0
MD Max(mm)	1.5
PT Max(mm)	18.0
DP Min(mm)	14.5

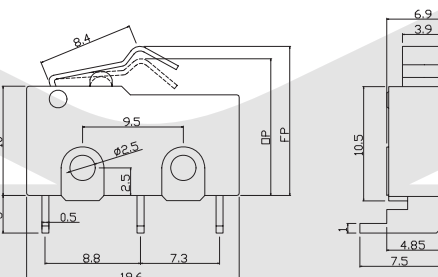

Model	KLS7-KW4-3Z-B142013L5
DF (N)	0.2~3.0
MD Max(mm)	0.5
PT Max(mm)	15.5
DP Min(mm)	14.1

Micro Switch Series

KLS7-KW4-3Z Micro Switch Series

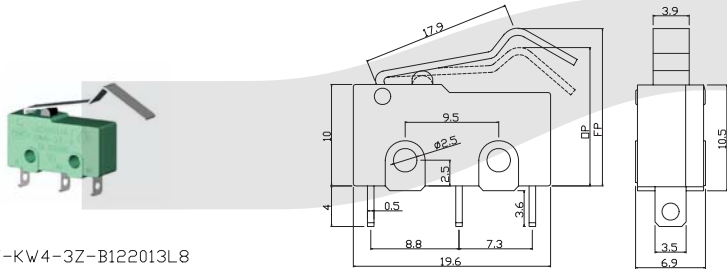

KLS7-KW4-3Z-B122013L8

Model	KLS7-KW4-3Z-B122013L8
DF (N)	0.2~3.0
MD Max(mm)	1.0
PT Max(mm)	18.0
DP Min(mm)	13.5

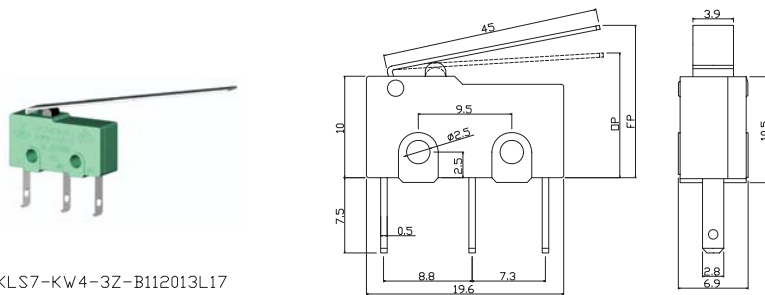

KLS7-KW4-3Z-B112013L17

Model	KLS7-KW4-3Z-B112013L17
DF (N)	0.2~3.0
MD Max(mm)	2.0
PT Max(mm)	20.0
DP Min(mm)	14.0