

Cree® J Series™ 5630 LEDs

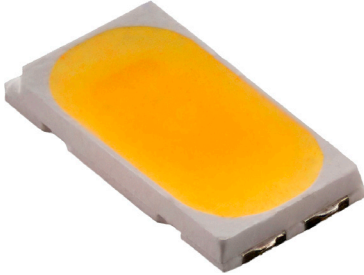

PRODUCT DESCRIPTION

J Series™ LEDs extend Cree’s industry-leading portfolio of lighting-class LEDs to a broader set of applications. The J Series 5630 LEDs combine high efficacy and excellent value in a reliable PCT package. The J Series 5630 LEDs are optimized for applications where high efficacy and smooth appearance are critical, such as troffers, panel and outdoor area lights.

FEATURES

- Industry-compatible size : 5.6 x 3.0 x 0.6 mm
- 3-V configuration
- Flux binned at 25 °C, chromaticity binned at 85 °C
- 6500 K–2700 K ANSI CCTs available
- 70, 80 & 90 CRI available for all CCTs
- RoHS and REACH compliant

PRODUCT SUMMARY

Product	Power Class	Test Temperature	Test Current	Typical Forward Voltage	4000 K, 70 CRI		3000 K, 80 CRI		Maximum Current
					Typical Flux	Typical Efficacy	Typical Flux	Typical Efficacy	
JB5630	0.2 W	25 °C	65 mA	2.8 V	36.6 lm	201 LPW	32.3 lm	178 LPW	240 mA



J Series™ Products are sold exclusively by Cree Venture LED Company Limited (“Cree Venture”), regardless of geography. Any orders for J Series Products that are submitted to Cree, Inc. or any of its other subsidiaries will be directed to Cree Venture for acknowledgement and order fulfillment.

TABLE OF CONTENTS

Order Code & Bin Code Formats	3
Characteristics	4
Operating Limits.....	4
Flux Characteristics, Order Codes and Bins.....	5
Relative Luminous Flux vs. Current.....	6
Electrical Characteristics.....	6
Relative Chromaticity vs. Current.....	7
Relative Chromaticity vs. Temperature.....	7
Relative Spectral Power Distribution	8
Relative Luminous Flux vs. Junction Temperature	9
Typical Spatial Distribution.....	9
Performance Groups - Luminous Flux.....	10
Performance Groups - Forward Voltage.....	10
Performance Groups - Chromaticity	11
Reflow Soldering Characteristics.....	20
Notes	21
Mechanical Dimensions	23
Tape & Reel.....	24
Packaging.....	25

ORDER CODE & BIN CODE FORMATS

Order codes and bin codes for J Series 5630 LEDs are configured in the following manner:

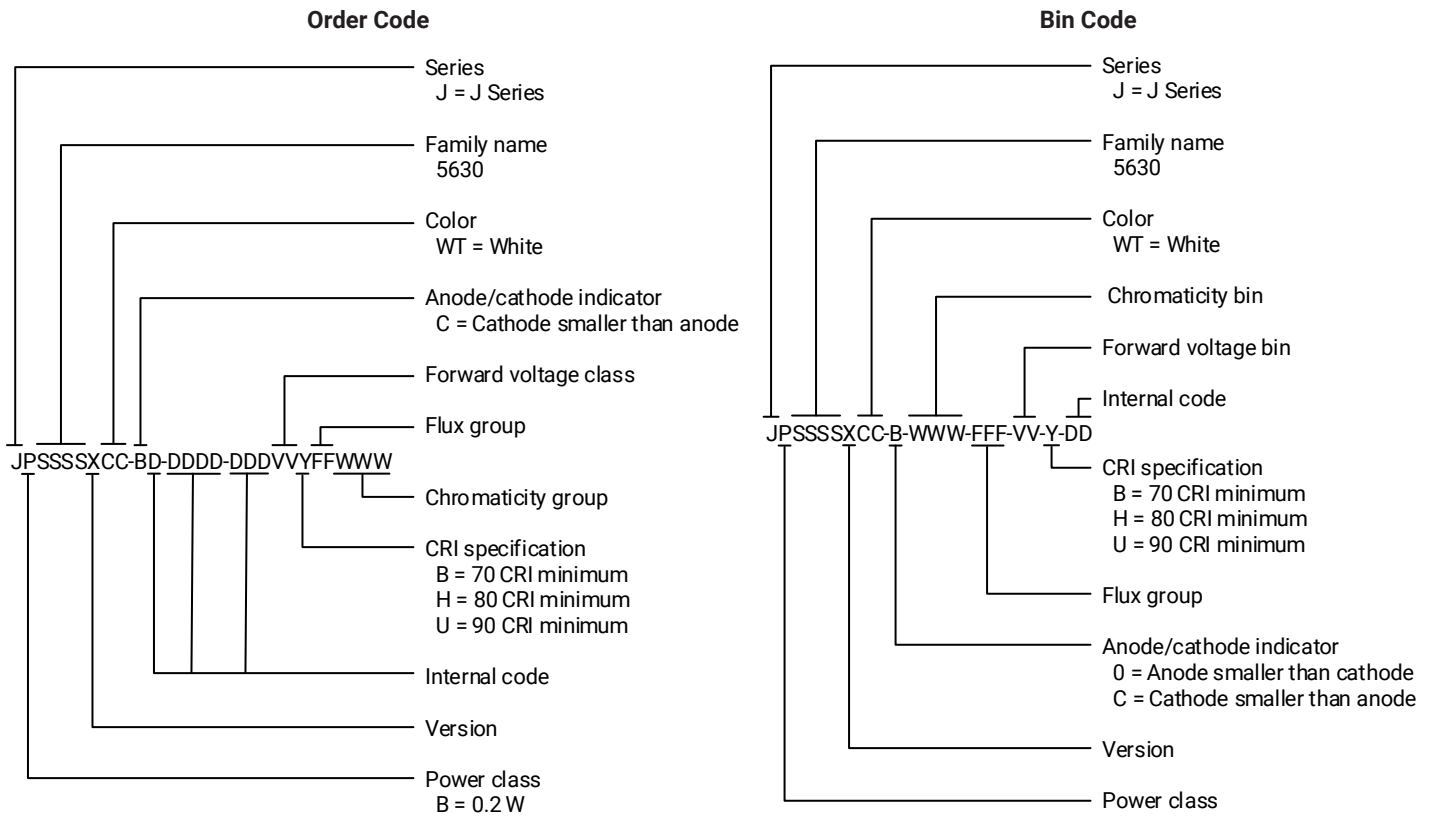

CHARACTERISTICS

Characteristics	Unit	Minimum	Typical	Maximum
Thermal resistance, junction to solder point	°C/W		13	
Viewing angle (FWHM)	degrees		120	
Temperature coefficient of voltage	mV/°C		-0.9	
ESD withstand voltage (JEDEC JS-001-2012)	V		Class 2	
DC forward current	mA			240
Reverse voltage	V			5
Forward voltage (@ 65 mA, 25 °C)	V		2.8	3.1
LED junction temperature	°C			125
Operating temperature	°C	-40		105

OPERATING LIMITS

The maximum forward current is determined by the thermal resistance between the LED junction and ambient.

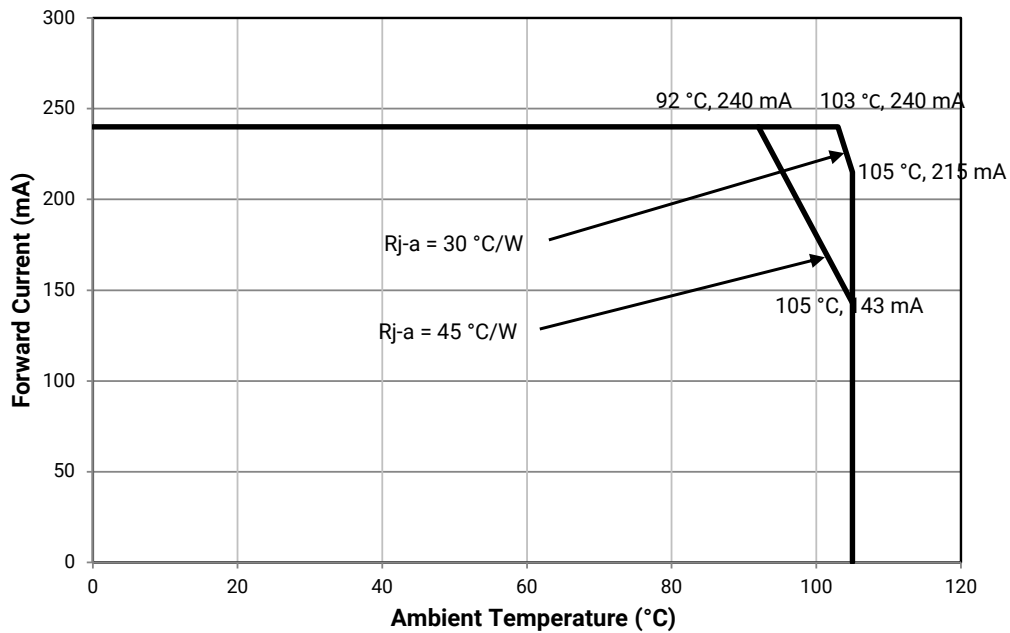

FLUX CHARACTERISTICS, ORDER CODES AND BINS ($I_F = 65 \text{ mA}$, $T_J = 25 \text{ °C}$)

The following table provides order codes for J Series JB5630 LEDs. For a complete description of the order code nomenclature, please see the Order Code and Bin Code Formats section (page 3). For definitions of the chromaticity kits, please see the Performance Groups - Chromaticity section (page 11).

Nominal CCT	Minimum CRI	Flux Group	Minimum Flux (lm) @ 25 °C	Typical Flux (lm) @ 25 °C	Typical Flux (lm) @ 85 °C*	Order Code
6500 K	70	D5	34	36.6	32.2	JB5630AWT-C0-0000-000A0BD565E
	80	D4	32	35	30.8	JB5630AWT-C0-0000-000A0HD465E
	90	C5	26	29.1	25.6	JB5630AWT-C0-0000-000A0UC565E
5700 K	70	D5	34	36.6	32.2	JB5630AWT-C0-0000-000A0BD557E
	80	D4	32	35	30.8	JB5630AWT-C0-0000-000A0HD457E
	90	C5	26	29.1	25.6	JB5630AWT-C0-0000-000A0UC557E
5000 K	70	D5	34	36.6	32.2	JB5630AWT-C0-0000-000A0BD550E
	80	D4	32	35	30.8	JB5630AWT-C0-0000-000A0HD450E
	90	C5	26	29.1	25.6	JB5630AWT-C0-0000-000A0UC550E
4500 K	70	D5	34	36.6	32.2	JB5630AWT-C0-0000-000A0BD545E
	80	D4	32	35	30.8	JB5630AWT-C0-0000-000A0HD445E
	90	C5	26	29.1	25.6	JB5630AWT-C0-0000-000A0UC545E
4000 K	70	D5	34	36.6	32.2	JB5630AWT-C0-0000-000A0BD540E
	80	D4	32	35	30.8	JB5630AWT-C0-0000-000A0HD440E
	90	C5	26	29.1	25.6	JB5630AWT-C0-0000-000A0UC540E
3500 K	70	D4	32	35	30.8	JB5630AWT-C0-0000-000A0BD435E
	80	D3	30	33.3	29.3	JB5630AWT-C0-0000-000A0HD335E
	90	C4	24	25.9	22.8	JB5630AWT-C0-0000-000A0UC435E
3000 K	70	D3	30	33.8	29.8	JB5630AWT-C0-0000-000A0BD330E
	80	D3	30	32.3	28.5	JB5630AWT-C0-0000-000A0HD330E
	90	C4	24	25.9	22.8	JB5630AWT-C0-0000-000A0UC430E
2700 K	70	D3	30	33.1	29.1	JB5630AWT-C0-0000-000A0BD327E
	80	D2	28	31.7	27.9	JB5630AWT-C0-0000-000A0HD227E
	90	C3	22	25.9	22.8	JB5630AWT-C0-0000-000A0UC327E

Notes:

- Cree Venture maintains a tolerance of $\pm 7\%$ on flux and power measurements, ± 0.005 on chromaticity (CCx, CCy) measurements and ± 2 on CRI measurements. See the Measurements section (page 21).
- Cree Venture J Series 5630 LED order codes specify only a minimum flux bin and not a maximum. Cree Venture may ship reels in flux bins higher than the minimum specified by the order code without advance notice. Shipments will always adhere to the chromaticity restrictions specified by the order code.
- * Flux values @ 85 °C are calculated and for reference only.

RELATIVE LUMINOUS FLUX VS. CURRENT

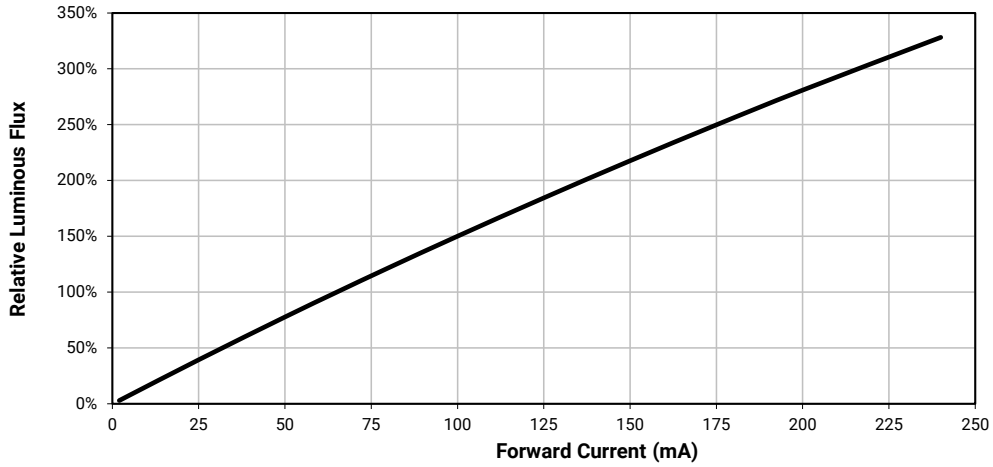

ELECTRICAL CHARACTERISTICS

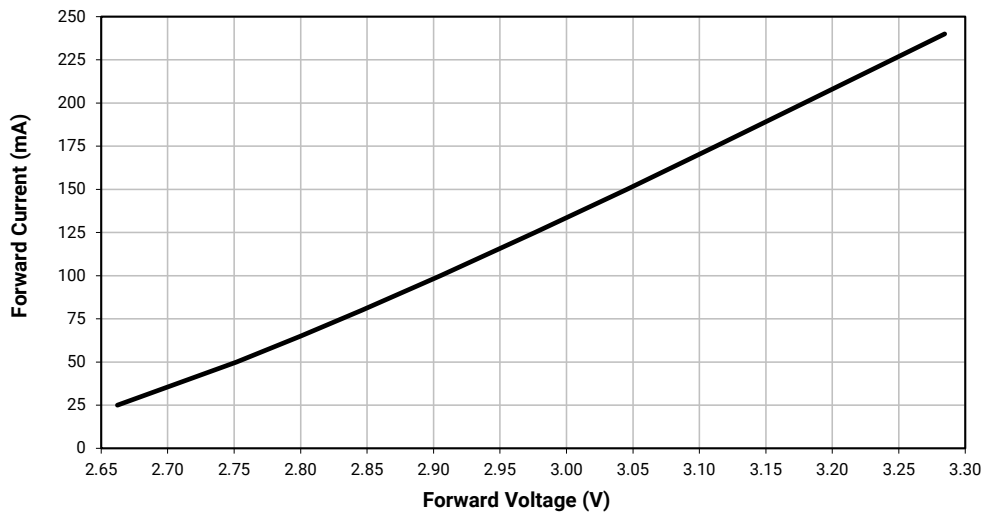

RELATIVE CHROMATICITY VS. CURRENT

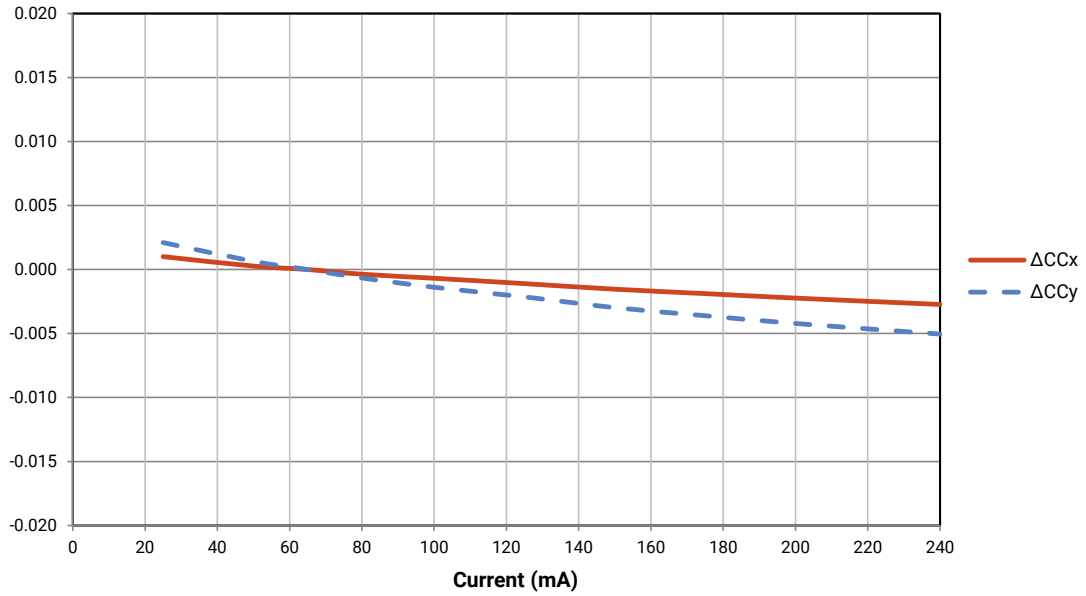

RELATIVE CHROMATICITY VS. TEMPERATURE

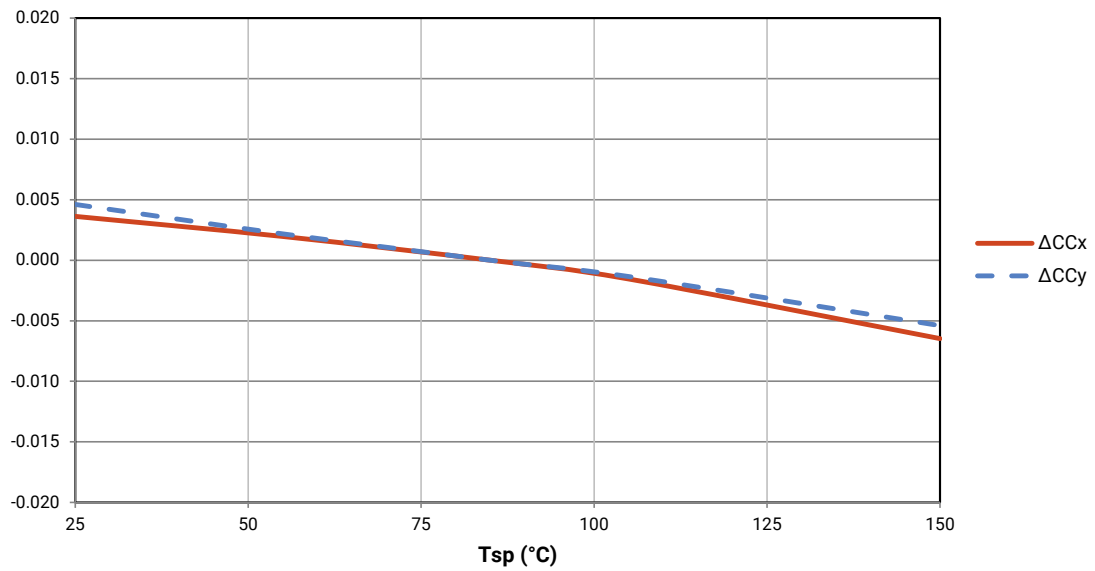

RELATIVE SPECTRAL POWER DISTRIBUTION

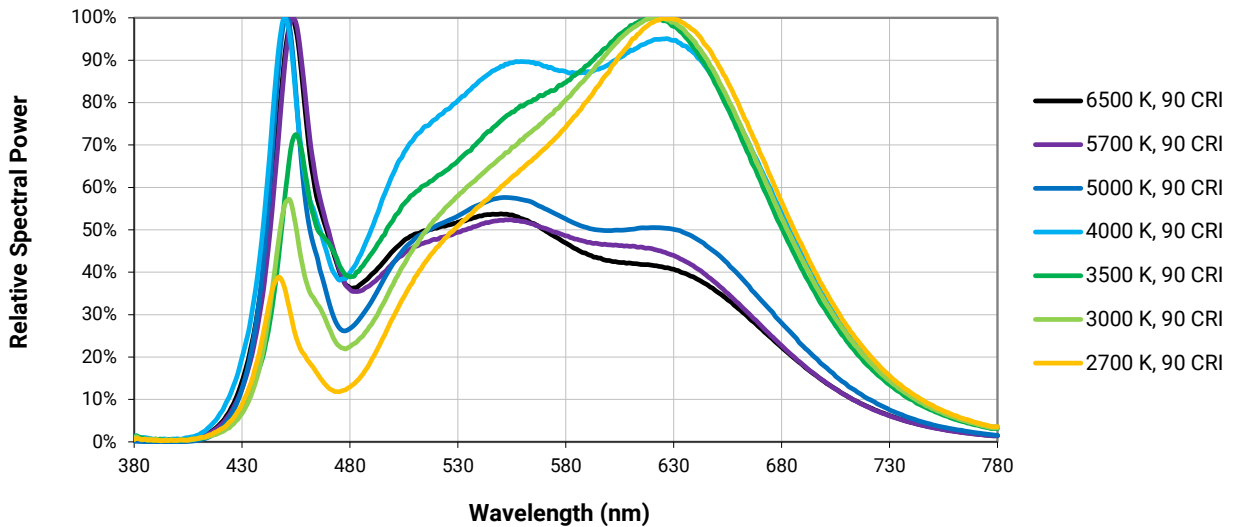
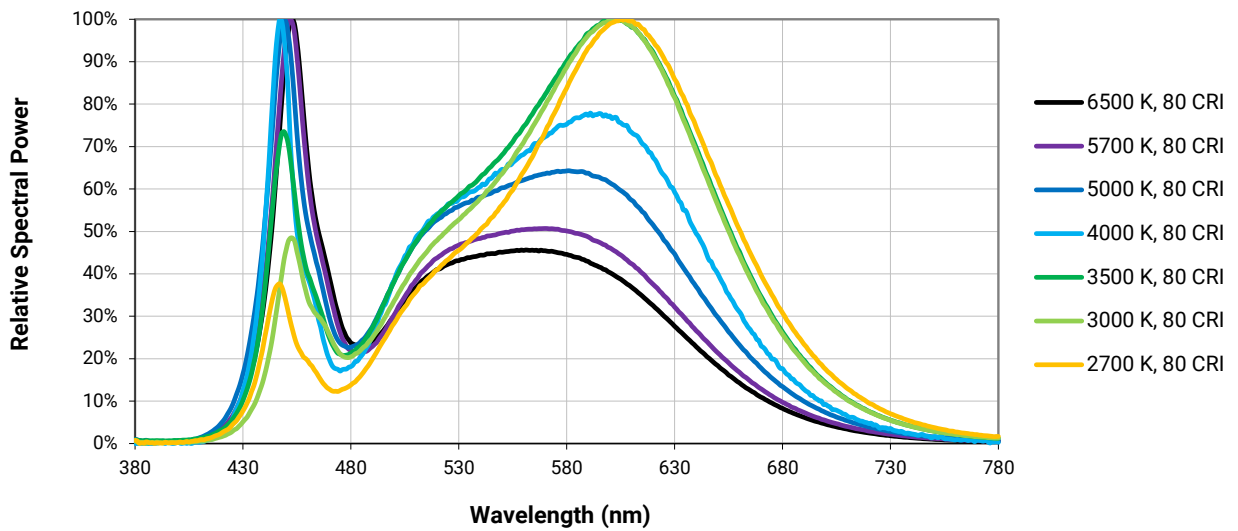
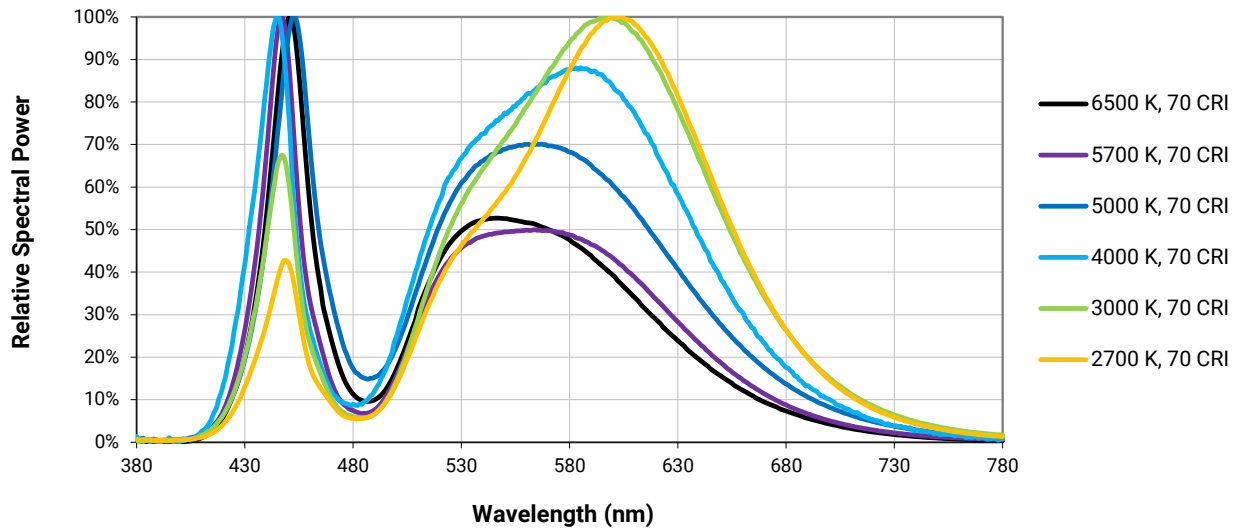

RELATIVE LUMINOUS FLUX VS. JUNCTION TEMPERATURE

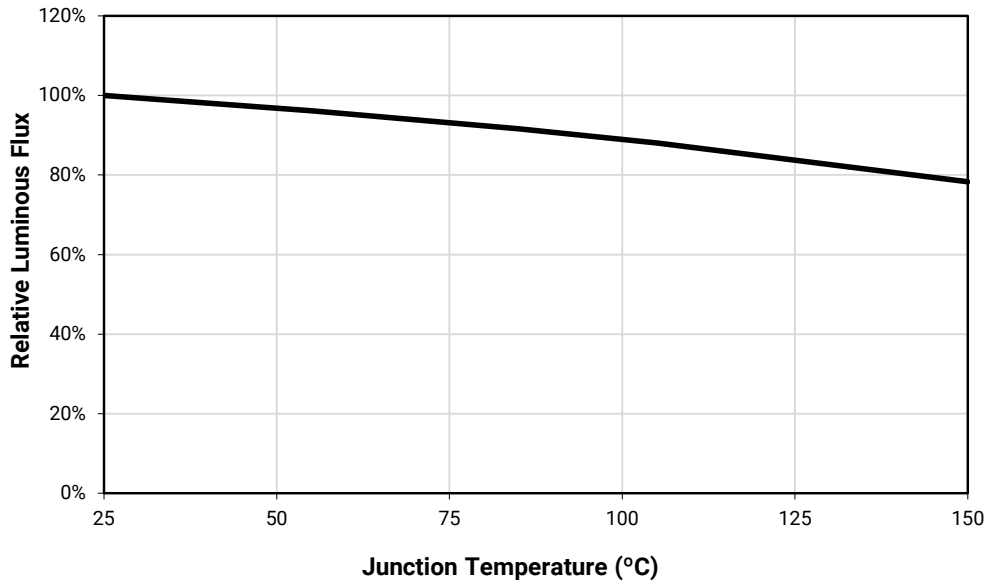

TYPICAL SPATIAL DISTRIBUTION

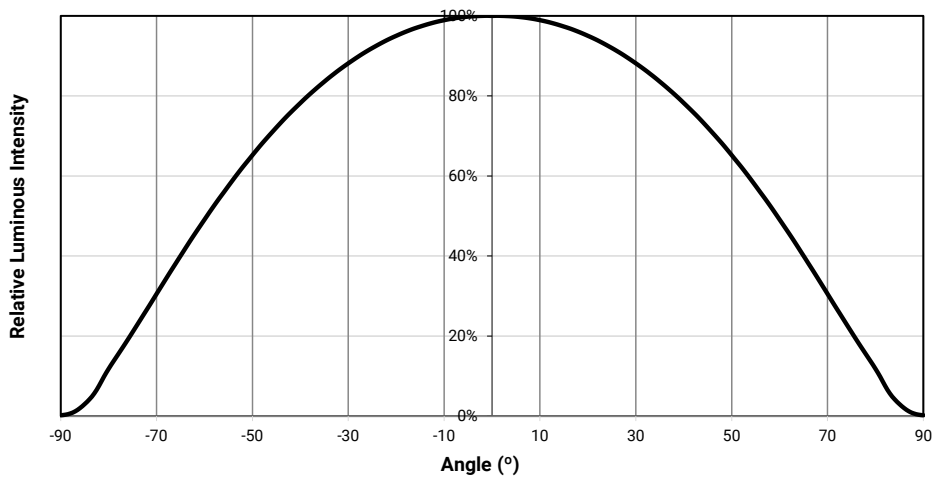

PERFORMANCE GROUPS - LUMINOUS FLUX ($T_j = 25\text{ }^\circ\text{C}$)

J Series JB5630 LEDs are tested for luminous flux at 65 mA and placed into one of the following luminous-flux groups.

Group Code	Minimum Luminous Flux (lm)	Maximum Luminous Flux (lm)
C2	20	22
C3	22	24
C4	24	26
C5	26	28
D2	28	30
D3	30	32
D4	32	34
D5	34	36
E2	36	38
E3	38	40
E4	40	42
E5	42	44

PERFORMANCE GROUPS - FORWARD VOLTAGE ($T_j = 25\text{ }^\circ\text{C}$)

J Series 5630 LEDs are tested for forward voltage and placed into one of the following voltage bins.

The following voltage bins are indicated in the Forward Voltage Bin field in the bin code for JB5630 LEDs.

Voltage Bin	Minimum Forward Voltage (V)	Maximum Forward Voltage (V)
AC	2.6	2.7
AD	2.7	2.8
AE	2.8	2.9
AF	2.9	3.0
AG	3.0	3.1

PERFORMANCE GROUPS - CHROMATICITY

J Series 5630 LEDs are tested for chromaticity and placed into one of the regions defined by the following bounding coordinates.

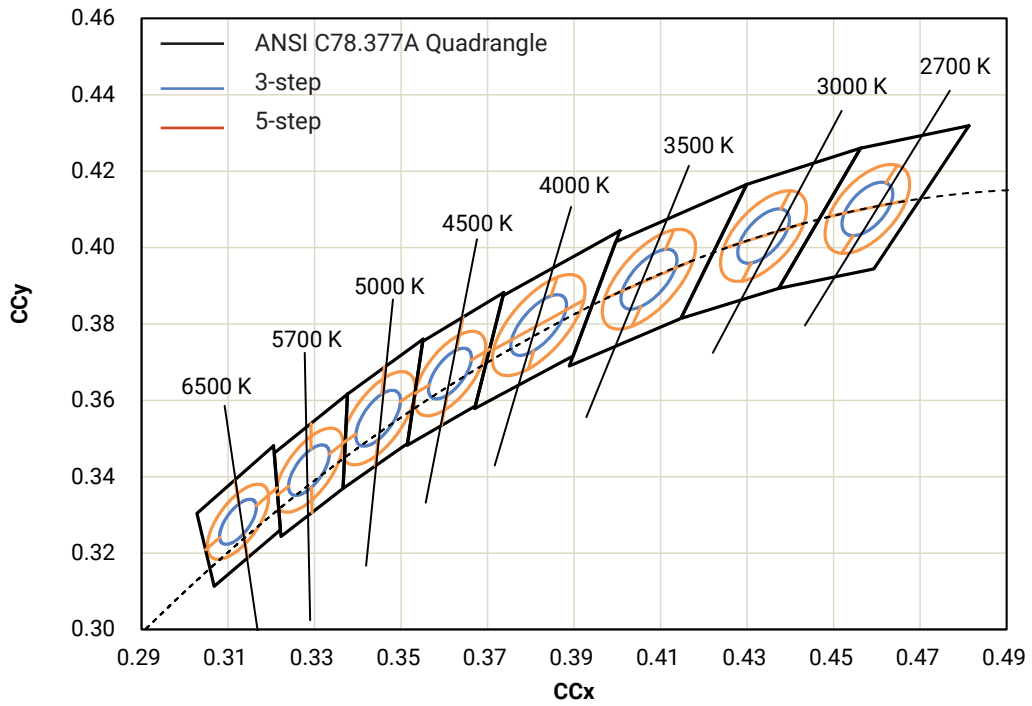

PERFORMANCE GROUPS - CHROMATICITY - CONTINUED

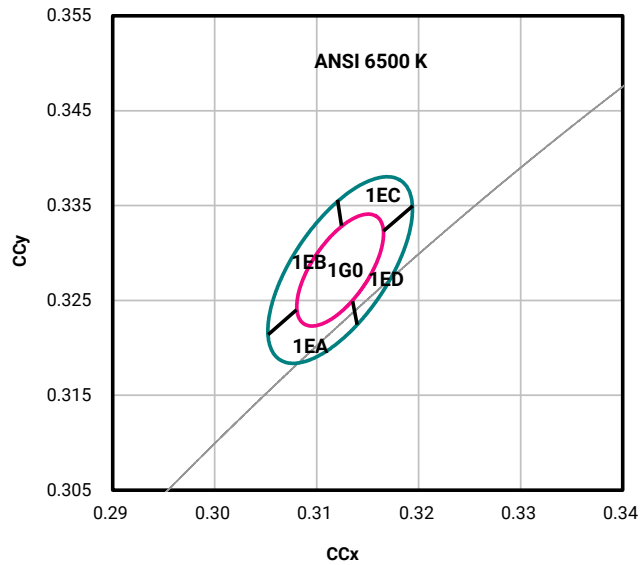

CCT	MacAdam Ellipse	Included Bins	Center Point		Major Axis	Minor Axis	Rotation Angle (°)
			x	y	a	b	
6500 K	3-step	1G0	0.3123	0.3282	0.00669	0.00285	58.57
	5-step	1G0, 1EA, 1EB, 1EC, 1ED	0.3123	0.3282	0.01115	0.00475	58.57

PERFORMANCE GROUPS - CHROMATICITY - CONTINUED

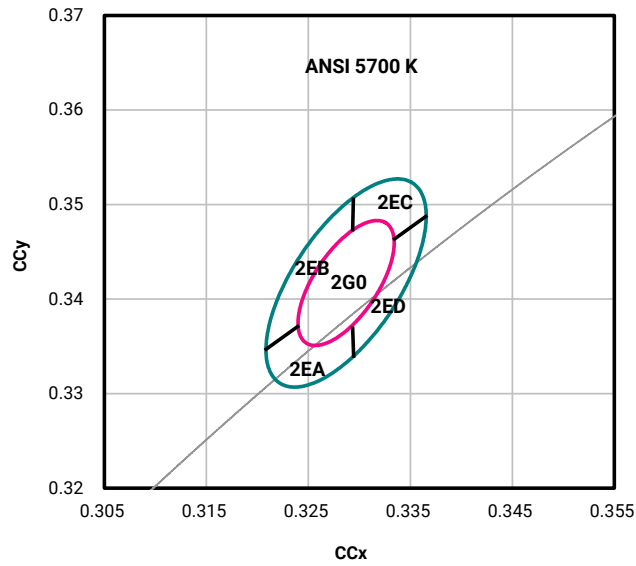

CCT	MacAdam Ellipse	Included Bins	Center Point		Major Axis	Minor Axis	Rotation Angle (°)
			x	y	a	b	
5700 K	3-step	2G0	0.3287	0.3417	0.00746	0.00320	59.09
	5-step	2G0, 2EA, 2EB, 2EC, 2ED	0.3287	0.3417	0.01243	0.00533	59.09

PERFORMANCE GROUPS - CHROMATICITY - CONTINUED

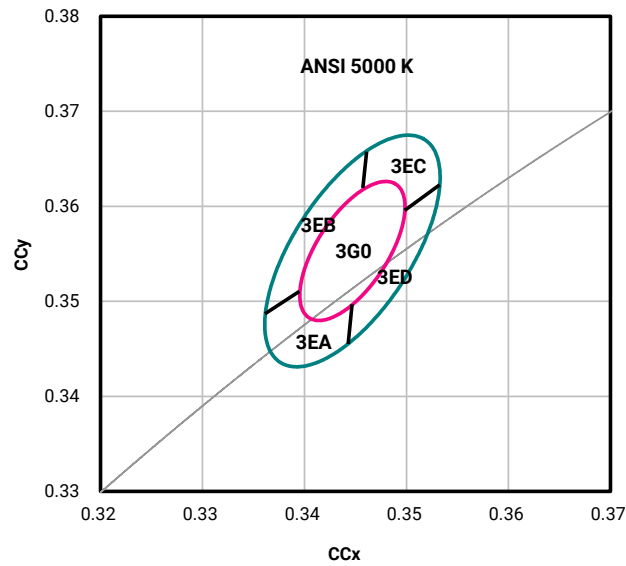

CCT	MacAdam Ellipse	Included Bins	Center Point		Major Axis	Minor Axis	Rotation Angle (°)
			x	y	a	b	
5000 K	3-step	3G0	0.3447	0.3553	0.00822	0.00354	59.62
	5-step	3G0, 3EA, 3EB, 3EC, 3ED	0.3447	0.3553	0.01370	0.00590	59.62

PERFORMANCE GROUPS - CHROMATICITY - CONTINUED

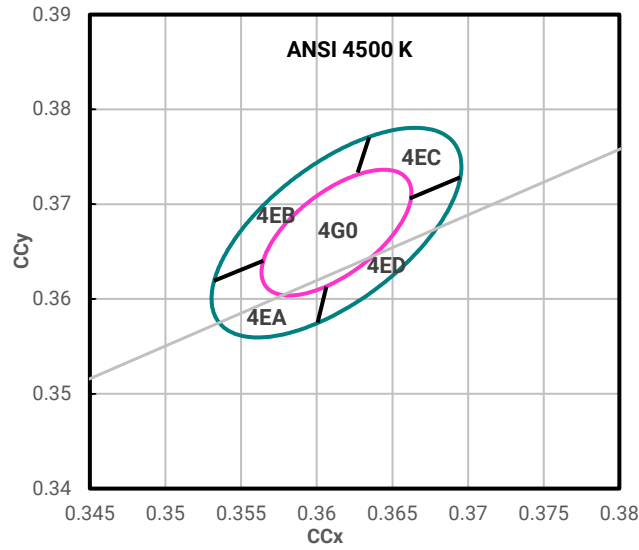

CCT	MacAdam Ellipse	Included Bins	Center Point		Major Axis	Minor Axis	Rotation Angle (°)
			x	y	a	b	
4500 K	3-step	4G0	0.3613	0.3670	0.00756	0.00338	57.58
	5-step	4G0, 4EA, 4EB, 4EC, 4ED	0.3613	0.3670	0.01260	0.00563	57.58

PERFORMANCE GROUPS - CHROMATICITY - CONTINUED

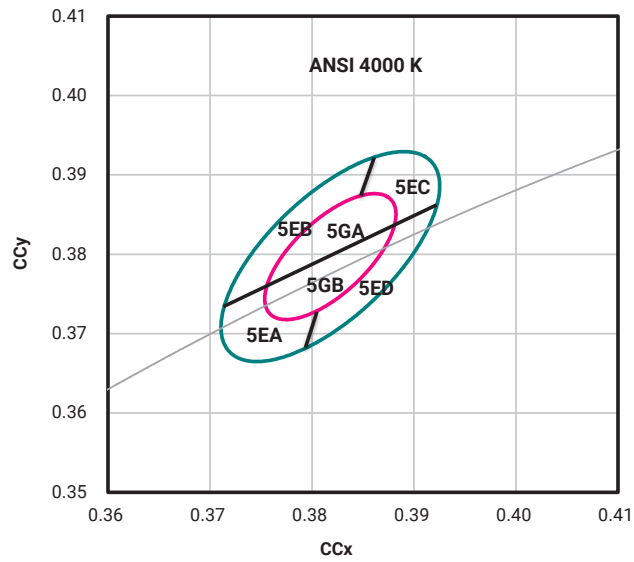

CCT	MacAdam Ellipse	Included Bins	Center Point		Major Axis	Minor Axis	Rotation Angle (°)
			x	y	a	b	
4000 K	3-step	5GA, 5GB	0.3818	0.3797	0.00939	0.00402	53.72
	5-step	5GA, 5GB, 5EA, 5EB, 5EC, 5ED	0.3818	0.3797	0.01565	0.00670	53.72

PERFORMANCE GROUPS - CHROMATICITY - CONTINUED

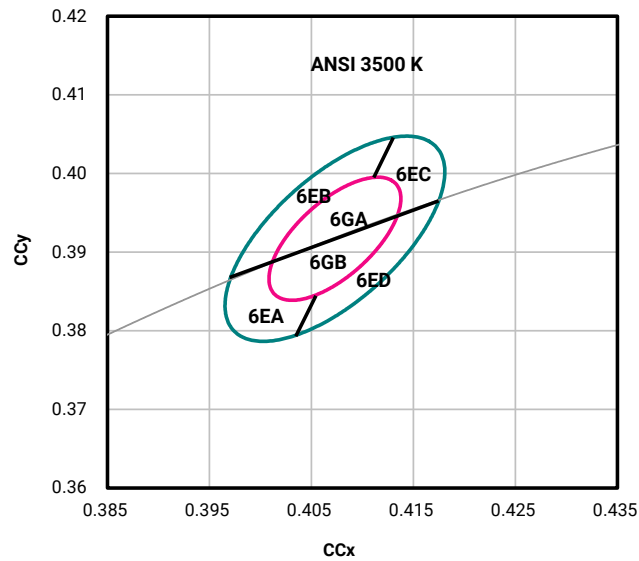

CCT	MacAdam Ellipse	Included Bins	Center Point		Major Axis	Minor Axis	Rotation Angle (°)
			x	y	a	b	
3500 K	3-step	6GA, 6GB	0.4073	0.3917	0.00927	0.00414	53.22
	5-step	6GA, 6GB, 6EA, 6EB, 6EC, 6ED	0.4073	0.3917	0.01545	0.00690	53.22

PERFORMANCE GROUPS - CHROMATICITY - CONTINUED

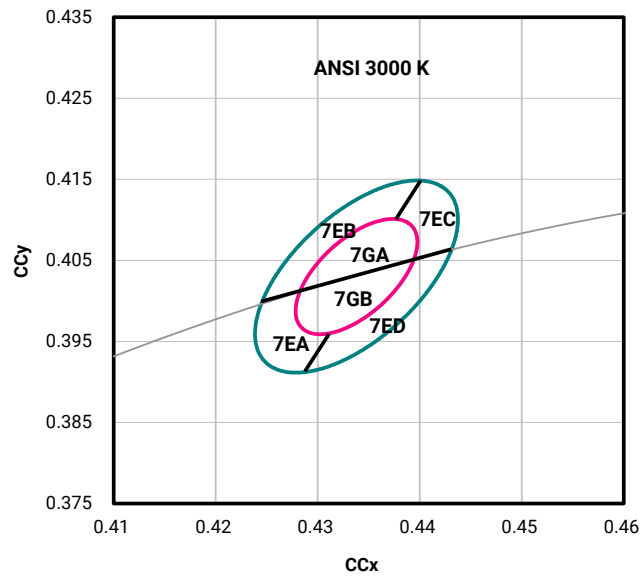

CCT	MacAdam Ellipse	Included Bins	Center Point		Major Axis	Minor Axis	Rotation Angle (°)
			x	y	a	b	
3000 K	3-step	7GA, 7GB	0.4338	0.4030	0.00834	0.00408	53.22
	5-step	7GA, 7GB, 7EA, 7EB, 7EC, 7ED	0.4338	0.4030	0.01390	0.00680	53.22

PERFORMANCE GROUPS - CHROMATICITY - CONTINUED

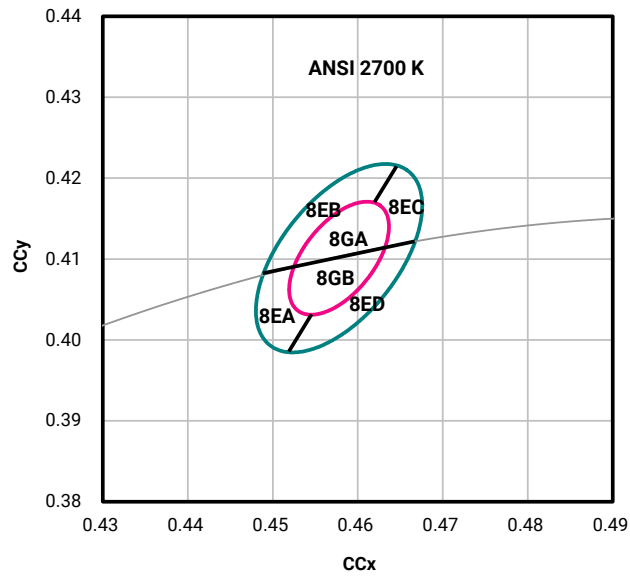

CCT	MacAdam Ellipse	Included Bins	Center Point		Major Axis	Minor Axis	Rotation Angle (°)
			x	y	a	b	
2700 K	3-step	8GA, 8GB	0.4578	0.4101	0.00810	0.00420	53.70
	5-step	8GA, 8GB, 8EA, 8EB, 8EC, 8ED	0.4578	0.4101	0.01350	0.00700	53.70

REFLOW SOLDERING CHARACTERISTICS

In testing, Cree Venture has found J Series 5630 LEDs to be compatible with JEDEC J-STD-020C, using the parameters listed below. As a general guideline, Cree Venture recommends that users follow the recommended soldering profile provided by the manufacturer of the solder paste used, and therefore it is the lamp or luminaire manufacturer’s responsibility to determine applicable soldering requirements.

Note that this general guideline may not apply to all PCB designs and configurations of reflow soldering equipment.

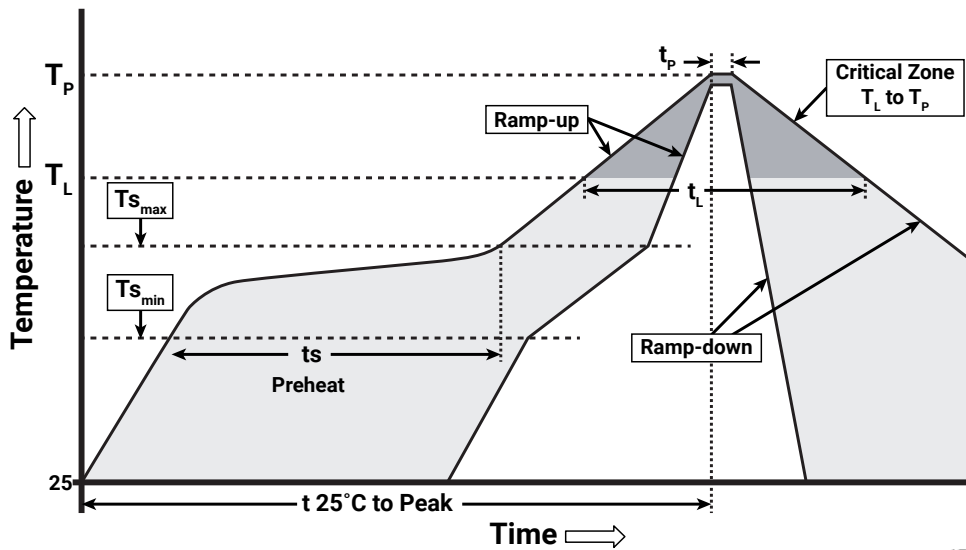

IPC/JEDEC J-STD-020C

Profile Feature	Lead-Free Solder
Temperature Min. ($T_{s_{min}}$)	150 °C
Temperature Max. ($T_{s_{max}}$)	200 °C
Time (t_s) from $T_{s_{min}}$ to $T_{s_{max}}$	60-120 seconds
Ramp-Up Rate (T_L to T_P)	3 °C/second
Liquidus Temperature (T_L)	217 °C
Time (t_L) Maintained Above T_L	60-150 seconds
Peak Package Body Temperature (T_p)	260 °C max.
Time (t_p) Within 5 °C of the Specified Classification Temperature (T_c)	30 seconds max.
Ramp-Down Rate (T_p to T_L)	6 °C/second max.
Time 25 °C to Peak Temperature	8 minutes max.

Note: All temperatures refer to the topside of the package, measured on the package body surface.

NOTES

Measurements

The luminous flux, radiant power, chromaticity, forward voltage and CRI measurements in this document are binning specifications only and solely represent product measurements as of the date of shipment. These measurements will change over time based on a number of factors that are not within Cree Venture’s control and are not intended or provided as operational specifications for the products. Calculated values are provided for informational purposes only and are not intended or provided as specifications.

Pre-Release Qualification Testing

Please read the [J Series Reliability Overview](#) for the details of the pre-release qualification testing for J Series LEDs.

Lumen Maintenance

Cree Venture uses standardized IES LM-80-08 and TM-21-11 methods for collecting long-term data and extrapolating LED lumen maintenance. For information on the specific LM-80 data sets available for this LED, refer to the public [J Series LM-80 results document](#).

Please read the [Thermal Management application note](#) for details on how thermal design, ambient temperature, and drive current affect the LED junction temperature.

Moisture Sensitivity

Cree Venture recommends keeping J Series 5630 LEDs in the provided, resealable moisture-barrier packaging (MBP) until immediately prior to soldering. Unopened MBP that contains J Series 5630 LEDs does not need special storage for moisture sensitivity.

Once the MBP is opened, J Series 5630 LEDs should be handled and stored as MSL 3 per JEDEC J-STD-033, meaning they have limited exposure time before damage to the LED may occur during the soldering operation. The table on the right specifies the maximum exposure time in days depending on temperature and humidity conditions. LEDs with exposure time longer than the specified maximums must be baked according to the baking conditions listed below.

Moisture Sensitivity Level	Temp.	Maximum Percent Relative Humidity				
		50%	60%	70%	80%	90%
Level 3	35 °C	8	5	1	0.5	0.5
Level 3	30 °C	11	7	1	1	1
Level 3	25 °C	14	10	2	1	1
Level 3	20 °C	20	13	2	1	1

Baking Conditions

It is not necessary to bake all J Series 5630 LEDs. Only the LEDs that meet all of the following criteria must be baked:

1. LEDs that have been removed from the original MBP.
2. LEDs that have been exposed to a humid environment longer than listed in the Moisture Sensitivity section above.
3. LEDs that have not been soldered.

LEDs should be baked at 60 °C for 24 hours. LEDs may be baked in the original reels. Remove LEDs from the MBP before baking. Do not bake parts at temperatures higher than 60 °C. This baking operation resets the exposure time as defined in the Moisture Sensitivity section above.

NOTES - CONTINUED

RoHS Compliance

The levels of RoHS restricted materials in this product are below the maximum concentration values (also referred to as the threshold limits) permitted for such substances, or are used in an exempted application, in accordance with EU Directive 2011/65/EC (RoHS2), as implemented January 2, 2013. RoHS Declarations for this product can be obtained from your Cree representative or from the [Product Ecology](#) section of the Cree website.

REACH Compliance

REACH substances of very high concern (SVHCs) information is available for this product. Since the European Chemical Agency (ECHA) has published notice of their intent to frequently revise the SVHC listing for the foreseeable future, please contact a Cree representative to insure you get the most up-to-date REACH SVHC Declaration. REACH banned substance information (REACH Article 67) is also available upon request.

Vision Advisory

WARNING: Do not look at an exposed lamp in operation. Eye injury can result. For more information about LEDs and eye safety, please refer to the [J Series LED Eye Safety application note](#).

MECHANICAL DIMENSIONS

Thermal vias, if present, are not shown on these drawings.
 All measurements are ± 0.2 mm unless otherwise indicated.

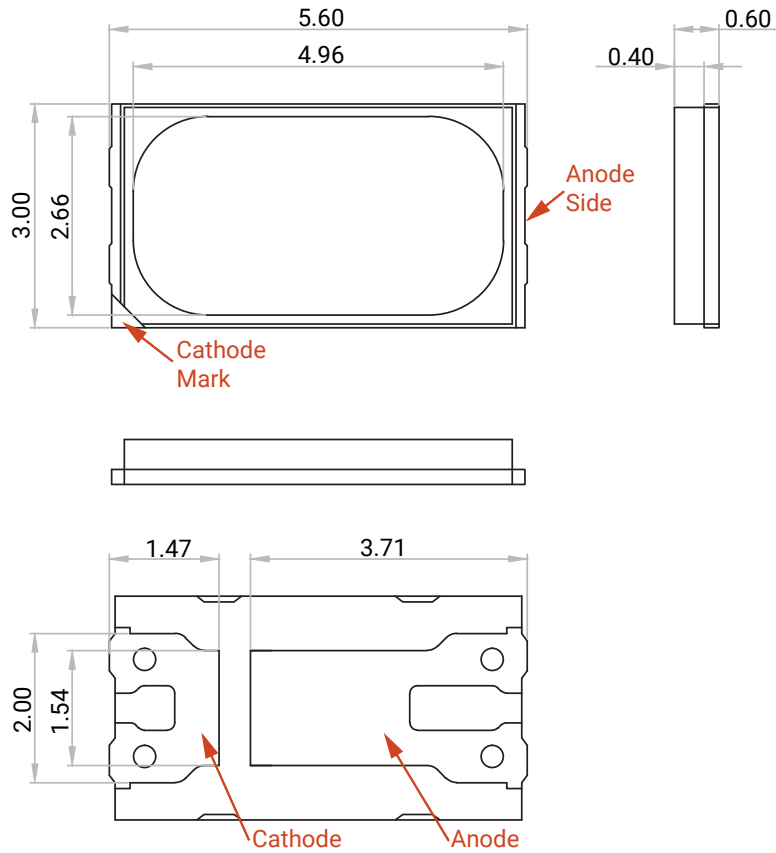

All measurements are ± 0.1 mm unless otherwise indicated.

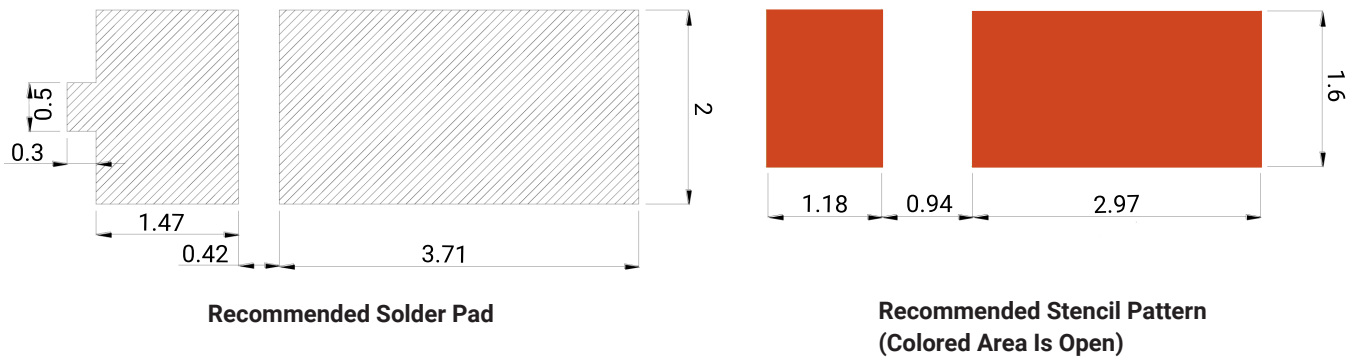

TAPE & REEL

All Cree Venture carrier tapes conform to EIA-481D, Automated Component Handling Systems Standard.

All dimensions in mm.

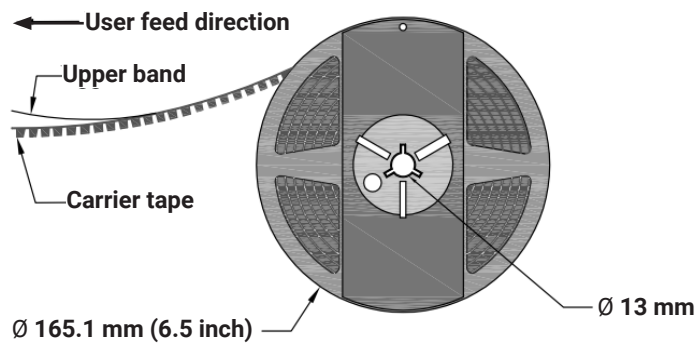
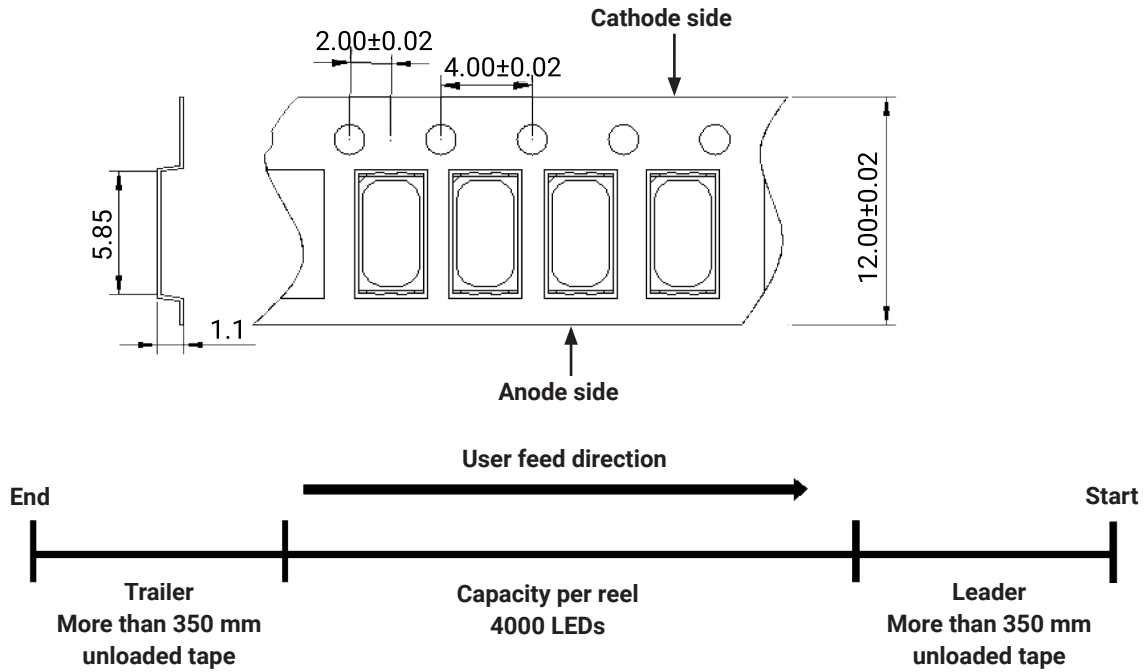

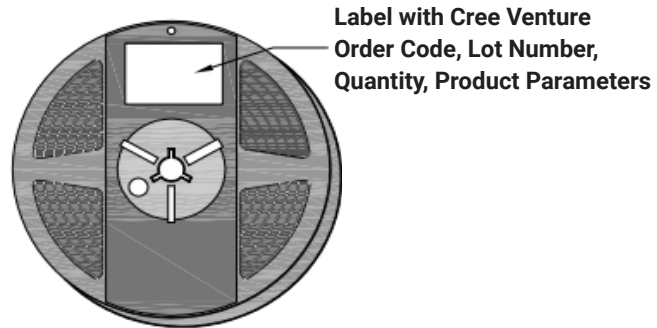
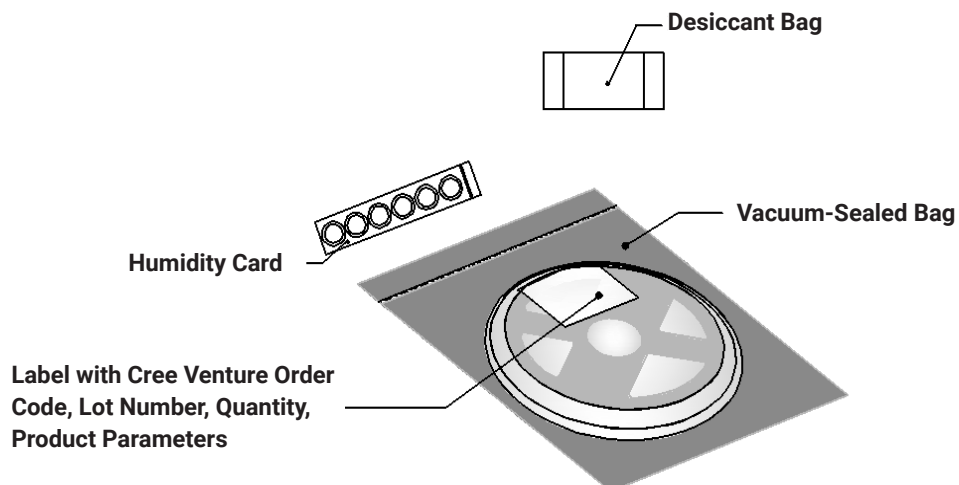
PACKAGING**Unpackaged Reel****Packaged Reel**

PACKAGING - CONTINUED

J Series 5630 LEDs are packaged in boxes for shipment. Box sizes and the number of reels per box are as follows.

Box	Box Dimensions	Number of Reels per Box
1	250 x 210 x 30 mm	2
2	250 x 210 x 50 mm	4
3	530 x 230 x 275 mm	44
4	530 x 443 x 275 mm	88

Each box has at least one label (shown as a white square in the diagrams below) showing the order code, lot number, quantity, and product parameters.

Box 1

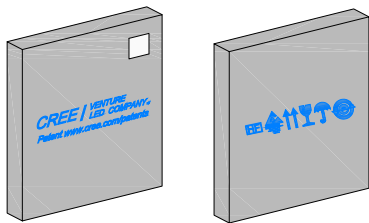

Box 2

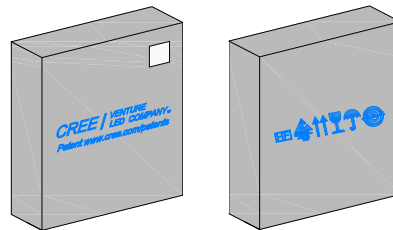

Box 3

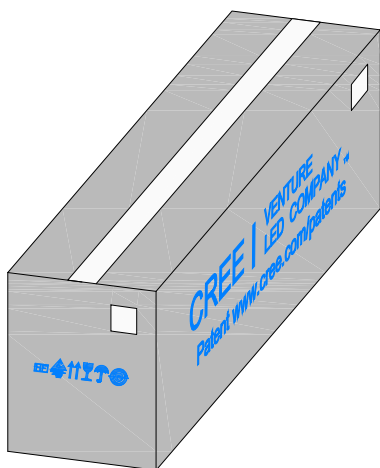

Box 4

