

HF13F

MINIATURE INTERMEDIATE POWER RELAY



File No.:E133481



File No.:R50154518



File No.:CQC09002030028 (DC type)
CQC09002030029 (AC type)



Features

- 1C: 15A; 2C:10A switching capability
- Various terminals available
- Sockets available
- Conform to the CE low voltage directive
- 1 & 2 pole configurations
- Environmental friendly product (RoHS compliant)
- Outline Dimensions: (28.0 x 21.5 x 35.0)mm

CONTACT DATA

Contact arrangement	1A,1C	2A,2C
Contact resistance	100mΩ max.(at 1A 6VDC)	
Contact material	See ordering info.	
Contact rating (Res. load)	15A 250VAC/30VDC	10A 250VAC/30VDC
Max. switching voltage	250VAC / 30VDC	
Max. switching current	15A	10A
Max. switching power	3750VA/450W	2500VA/300W
Mechanical endurance	1 x 10 ⁷ ops	
Electrical endurance	1 x 10 ⁵ ops (See approval reports for more details)	

CHARACTERISTICS

Insulation resistance	500MΩ (at 500VDC)	
Dielectric strength	Between coil & contacts	1500VAC 1min
	Between open contacts	1000VAC 1min
	Between contact sets	1500VAC 1min
Operate time (at nomi. volt.)	25ms max.	
Release time (at nomi. volt.)	25ms max.	
Temperature rise (no-load, at nomi.volt.)	60K max.	
Shock resistance	Functional	98m/s ²
	Destructive	980m/s ²
Vibration resistance	10Hz to 55Hz 1mm DA	
Humidity	5% to 85% RH	
Ambient temperature	-40°C to 70°C	
Termination	PCB, Plug-in	
Unit weight	Approx. 37g	
Construction	Dust protected	

Notes: 1) The data shown above are initial values.
2) UL insulation system: Class B

COIL

Coil power	DC type: Approx. 0.9W to 1.1W AC type: Approx. 1.2VA to 1.8VA
------------	--

COIL DATA

at 23°C				
Nominal Voltage VDC	Pick-up Voltage VDC max.	Drop-out Voltage VDC min.	Max. Allowable Voltage VDC	Coil Resistance Ω
5	4.0	0.5	5.5	27.5 x (1±10%)
6	4.8	0.6	6.6	40 x (1±10%)
12	9.6	1.2	13.2	160 x (1±10%)
24	19.2	2.4	26.4	650 x (1±10%)
48	38.4	4.8	52.8	2600 x (1±10%)
110	88.0	11.0	121	11000 x (1±10%)
125	100	12.5	137.5	14000 x (1±10%)
220	176	22.0	242	53750 x (1±10%)

Nominal Voltage VAC	Pick-up Voltage VAC max.	Drop-out Voltage VAC min.	Max. Allowable Voltage VAC	Coil Resistance Ω
6	4.80	1.8	6.6	11.5 x (1±10%)
12	9.60	3.6	13.2	46 x (1±10%)
24	19.2	7.2	26.4	184 x (1±10%)
48	38.4	14.4	52.8	735 x (1±10%)
120	96.0	36.0	132	4550 x (1±10%)
220/240	176.0	72.0	264	14400 x (1±10%)

SAFETY APPROVAL RATINGS

UL/CUL	AgCdO	1 Form C	15A 250VAC/30VDC
	AgCe	1 Form C	15A 250VAC/30VDC
		2 Form C	10A 250VAC/30VDC 1/3 HP 240VAC/120VAC
TÜV	AgCdO AgCe	2 Form C	10A 250VAC/30VDC

Notes: Only some typical ratings are listed above. If more details are required, please contact us.



HONGFA RELAY

ISO9001, ISO/TS16949, ISO14001, OHSAS18001, IECQ QC 080000 CERTIFIED

2013 Rev. 1.00

ORDERING INFORMATION

Type	HF13F / A 012 -2Z 1 1 D (XXX)	
Coil voltage form	A: AC Nil: DC	
Coil voltage	DC: 5VDC to 220VDC AC: 6VAC to 240VAC	
Contact arrangement	1H: 1 Form A 2H: 2 Form A 1Z: 1 Form C 2Z: 2 Form C	
Mounting termination (See the following)	1: Socket 2: PCB 5: Flange-Mounting	
Contact material	1: AgCe Nil: AgCdO	
LED	D: With LED Nil: Without LED	
Customer special code		

Notes: 1) We also can supply the special type with terminals numbered 1,2,3,4,5,6,7,8.

OUTLINE DIMENSIONS, WIRING DIAGRAM AND PC BOARD LAYOUT

Unit: mm

HF13F/□□□□-1Z1□

Outline Dimensions

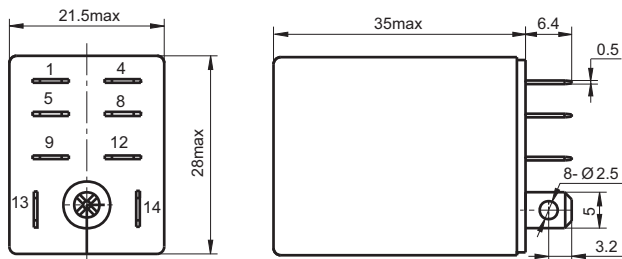

Wiring Diagram
(Bottom view)

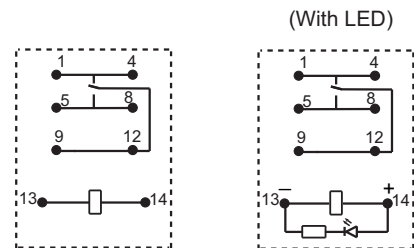

Remark: For AC parts with diode, the positive and negative pole markings on wiring diagram are not applicable.

HF13F/□□□□-2Z1□

Outline Dimensions

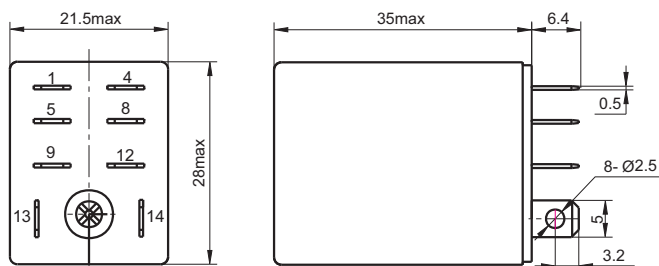

Wiring Diagram
(Bottom view)

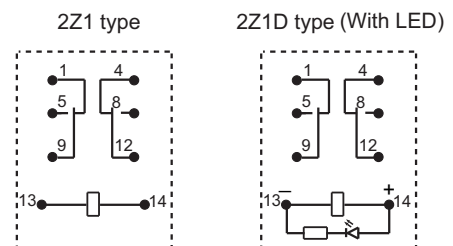

Remark: For AC parts with diode, the positive and negative pole markings on wiring diagram are not applicable.

OUTLINE DIMENSIONS, WIRING DIAGRAM AND PC BOARD LAYOUT

Unit: mm

HF13F/□□□□-2Z2□

Outline Dimensions

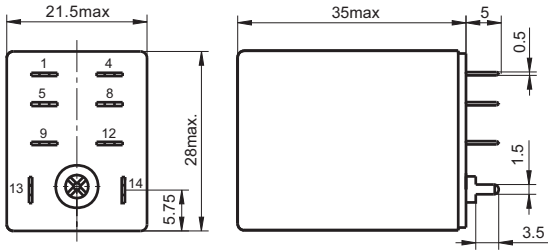

Wiring Diagram
(Bottom view)

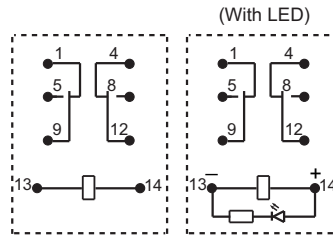

Remark: For AC parts with diode, the positive and negative pole markings on wiring diagram are not applicable.

PCB Layout
(Bottom view)

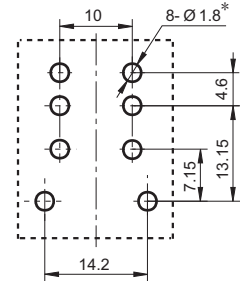

*: Please adjust the site of this diameter according to the actual application.

HF13F/□□□□-2Z5□

Outline Dimensions

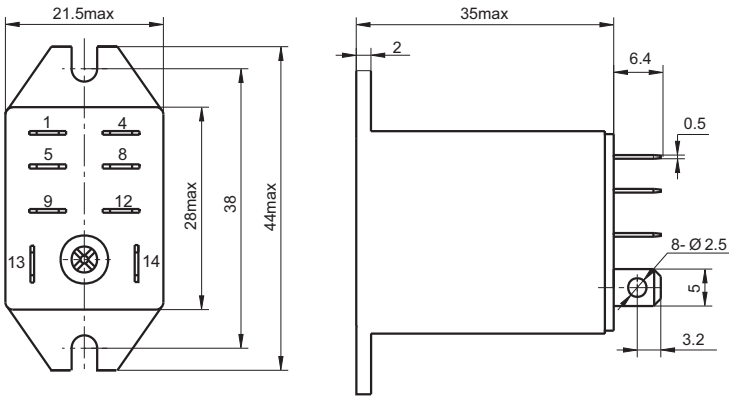

Mounting holes



Remark: 1) In case of no tolerance shown in outline dimension: outline dimension $\leq 1\text{mm}$, tolerance should be $\pm 0.2\text{mm}$; outline dimension $> 1\text{mm}$ and $\leq 5\text{mm}$, tolerance should be $\pm 0.3\text{mm}$; outline dimension $> 5\text{mm}$, tolerance should be $\pm 0.4\text{mm}$.
2) The tolerance without indicating for PCB layout is always $\pm 0.1\text{mm}$.

CHARACTERISTIC CURVES

MAXIMUM SWITCHING POWER(1C)

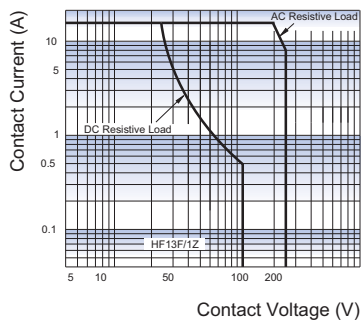

MAXIMUM SWITCHING POWER(2C)

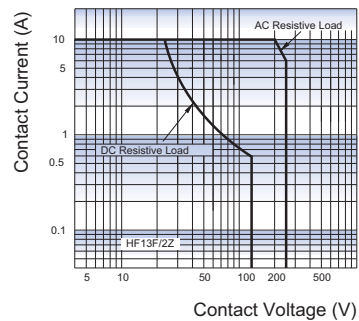

Relay Sockets



Features





- The dielectric strength can reach 2000VAC and the insulation resistance is 1000 MΩ
- Three mounting types are available: PCB mounting, screw mounting and DIN rail mounting.
- With finger protection device
- Components available: metallic retainer
- Environmental friendly product (RoHS compliant)

CHARACTERISTICS

Type	Nominal Voltage	Nominal Current	Ambient Temperature	Dielectric Strength min.	Screw Torque	Wire Strip Length
13F-2Z-A2	250VAC	10A	-40 °C to 70 °C	2000VAC	—	—
13F-2Z-C1	250VAC	10A	-40 °C to 70 °C	2000VAC	1.0N · m	7mm
13F-2Z-C2	250VAC	10A	-40 °C to 70 °C	2000VAC	1.0N · m	7mm

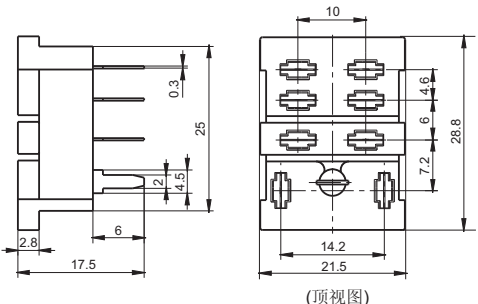
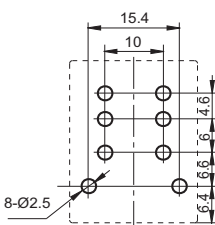
OUTLINE DIMENSIONS, WIRING DIAGRAM AND PC BOARD LAYOUT

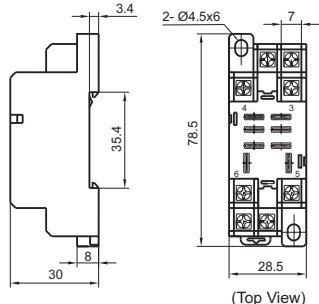
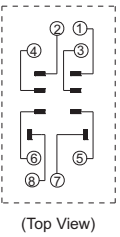
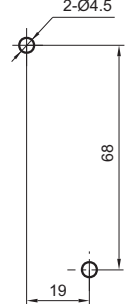
Unit: mm

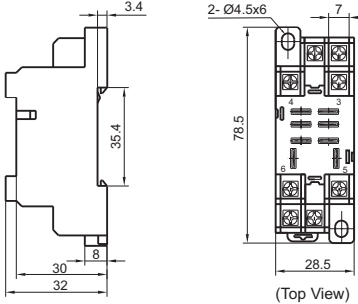
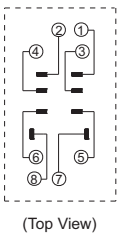
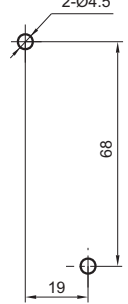
Socket	Outline Dimensions	Wiring Diagram	PCB Layout	Components Available
 PCB terminal, PCB mounting	 (顶视图)			metallic retainer 18FF-H1
 Screw terminal, DIN rail or Screw mounting, Without finger protection device	 (Top View)	 (Top View)		metallic retainer 18FF-H2 (be used in sets)
 Screw terminal, DIN rail or Screw mounting, With finger protection device	 (Top View)	 (Top View)		metallic retainer 18FF-H2 (be used in sets)

Retainer

18FF-H1 (metallic retainer)

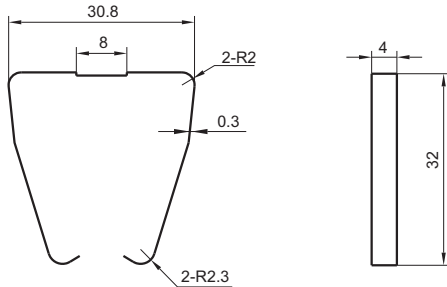

18FF-H2 (metallic retainer)

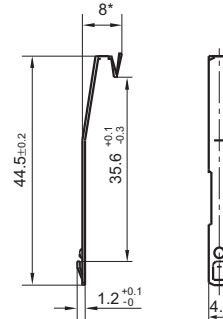

Note: 18FF-H2 retainer has to be used in sets, please pay special attention while placing the order.

Things to be noticed when selecting sockets:

1. Please choose suitable relay socket according to the actual mounting environment, relay contact poles and terminal layout. If there is any query on selection, please contact Hongfa for the technical service.
2. As for other related components, they should be selected separately. Please do give clear indication of the types of relay sockets and related components you choose while placing order.
3. The above is only an example of typical socket and related component type which is suitable to HF13F relay. If you have any special requirements, please contact us.

Disclaimer

This datasheet is for the customers' reference. All the specifications are subject to change without notice.

We could not evaluate all the performance and all the parameters for every possible application. Thus the user should be in a right position to choose the suitable product for their own application. If there is any query, please contact Hongfa for the technical service. However, it is the user's responsibility to determine which product should be used only.