

REVISION RECORD

REV	ECO	DESCRIPTION	DRFT	DATE
Δ		增加引脚	CSX	07/21/07
Δ		命名、料号增加环境标志“H”	LJH	12/08/07*
Δ		修改参数	LJH	12/18/08*
Δ		增加料号“3027C0Y01A” 及“3027C0Y01A(H)”	LJH	06/19/09*

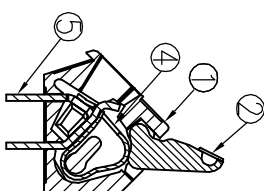

SECTION B-B

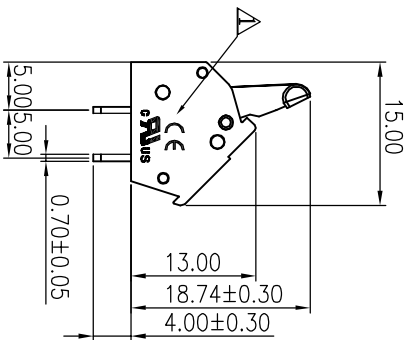
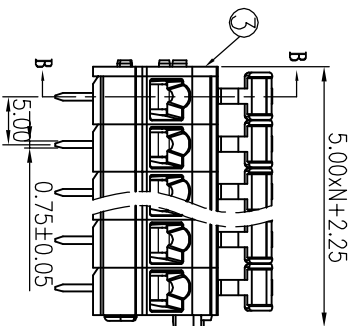
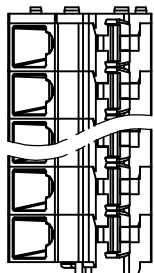
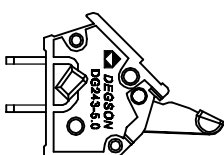

Notes:

1. Pitch: 5.0mm , Poles: XXP
2. Rated voltage/current: UL 300V/15A
IEC 250V/16A
3. Operation temperatures: -40℃~+105℃
4. Withstanding Voltage: AC2000V/1Min
5. Insulation Resistance: 5000MΩ/DC1000V
6. Wire Range: 28~12AWG, 2.5mm²
7. Undimensioned Tolerances:

Pitch range in mm	Nominal dimension range in mm	
over 6	over 30	over 100
to 10	to 60	to 150
to 10	to 24	to 30
to 10	to 30	to 60
to 10	to 30	to 100
to 10	to 24	to 150
H0.10	H0.15	H0.25
		±0.2 ±0.3 ±0.5 ±0.7 ±1.0 (0.05) to

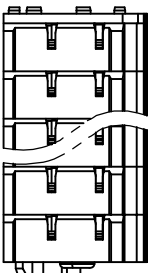
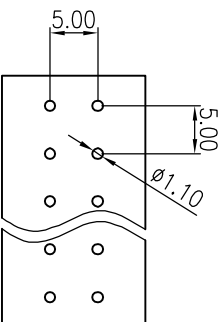

5	DC245 Pin header	3025B00010 (H)	XX	Phosphor bronze	SnCe
4	DC242 Spring	X000000991 (H)	XX	Stainless steel	
3	DC243-5.0-COVER	3027C0Y01A (H)	1	PA66	UL94V-0

ITEM	NAME OF PART	NO. OF PART	QTY	MATERIAL	NOTES
2	DC243-5.0-Button	3027D1701A (H)	XX	POM	UL94HB
1	DC243-5.0-Housing	3027A0Y01A (H)	XX	PA66	UL94V-0

DEGSON 宁波高压电子有限公司
DEGSON ELECTRONICS CO., LTD

NAME: DG243-5.0-XXP-1Y-00A(H)

DRAWING NO. DG243-5.0-E01

DO NOT SCALE DRAWING