

(Scale: 2 : 1)

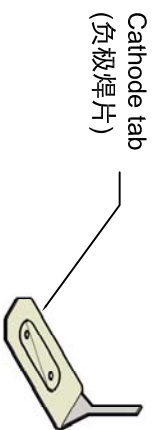

Yellow(黄色)
PVC

Cell(电芯):CR2032
210mAh

Anode tab
(正极焊片)

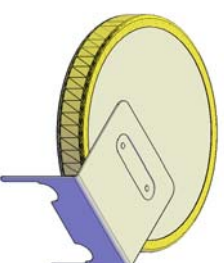
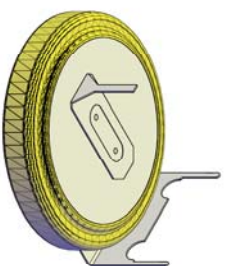
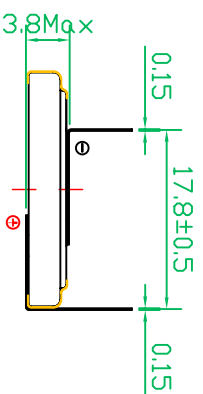
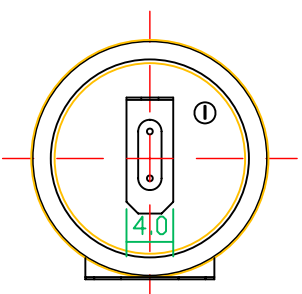
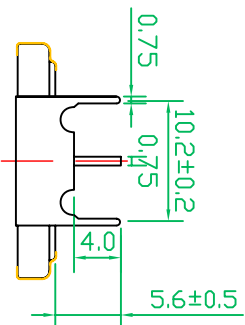
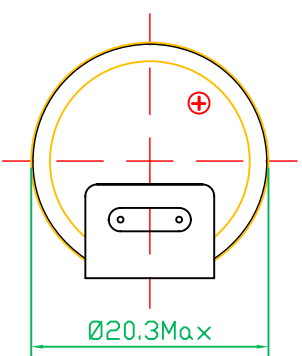

4 ROHS Compliant / 严格按照ROHS要求生产

3 Cathode tab / 负极焊片 Stainless steel plated with nickel / 不锈钢镀镍

2 Anode tab / 正极焊片 Stainless steel plated with nickel / 不锈钢镀镍

1 Cell / 电芯 Button, Yellow yellow PVC, with date code 扣式, 包黄色PVC, 电芯表面喷码

NO. Parts Description

EEMB
EEMB BATTERY

Drawn: Hexin Revise No.: E4-2009

Checked 1: Eivira Projection:

Checked 2: Page: 1/1

Approved: Scale: 1.5: 1

Title: CR2032-VAY3 File NO.: A10700 Draw Date: 2014/12/20 Unit: mm

1

2

3

4

5

6