

1.0A LOW DROPOUT LINEAR REGULATOR

NEW PRODUCT

Description

The AZ1117E is a low dropout three-terminal regulator with 1.0A output current ability, and the dropout voltage is specified at typical 1.1V at 1.0A current load, decreasing at lower load currents.

The AZ1117E has been optimized for low voltage where transient response and minimum input voltage are critical. It provides current limit and thermal shutdown protection solutions. Its circuit includes a trimmed band gap reference to assure output voltage accuracy to be within ±1%. On-chip thermal shutdown provides protection against a combination of high current and ambient temperature that would create excessive junction temperature.

The AZ1117E is available in 1.2V, 1.5V, 1.8V, 2.5V, 3.3V and 5.0V fixed output voltage versions and ADJ output voltage version. The fixed versions integrate the adjust resistors.

The AZ1117E is available in the industry-standard SOT-223 package.

Applications

- TVs and LCD Monitors
- PC Peripherals: Notebooks, Motherboards
- STB

Pin Assignments

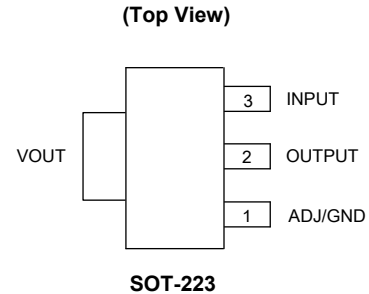

Features

- Provide ADJ Version ($V_{REF} = 1.25V$) and Fixed Voltage 1.2V, 1.5V, 1.8V, 2.5V, 3.3V and 5.0V with Accuracy ±1% (Except 1.2V)
- Current Limit: 1.3A (Typ.)
- Dropout Voltage: 1.1V (Typ.) @ $I_{OUT} = 1A$
- Regulator Stable with Low ESR MLCC
- Excellent Line Regulation: 0.001%/V (Typ.) @ $I_{OUT} = 30mA$
- Excellent Load Regulation: 0.2%/A @ $I_{OUT} = 1A$
- Quiescent Current: 3.5mA
- Low Output Noise
- PSRR: 70dB
- OTSD Protection
- Operation Junction Temperature: -40°C to +125°C
- **Totally Lead-Free & Fully RoHS Compliant (Notes 1 & 2)**
- **Halogen and Antimony Free. "Green" Device (Note 3)**

- Notes:
1. No purposely added lead. Fully EU Directive 2002/95/EC (RoHS) & 2011/65/EU (RoHS 2) compliant.
 2. See http://www.diodes.com/quality/lead_free.html for more information about Diodes Incorporated's definitions of Halogen- and Antimony-free, "Green" and Lead-free.
 3. Halogen- and Antimony-free "Green" products are defined as those which contain <900ppm bromine, <900ppm chlorine (<1500ppm total Br + Cl) and <1000ppm antimony compounds.

Typical Applications Circuit (Note 4)

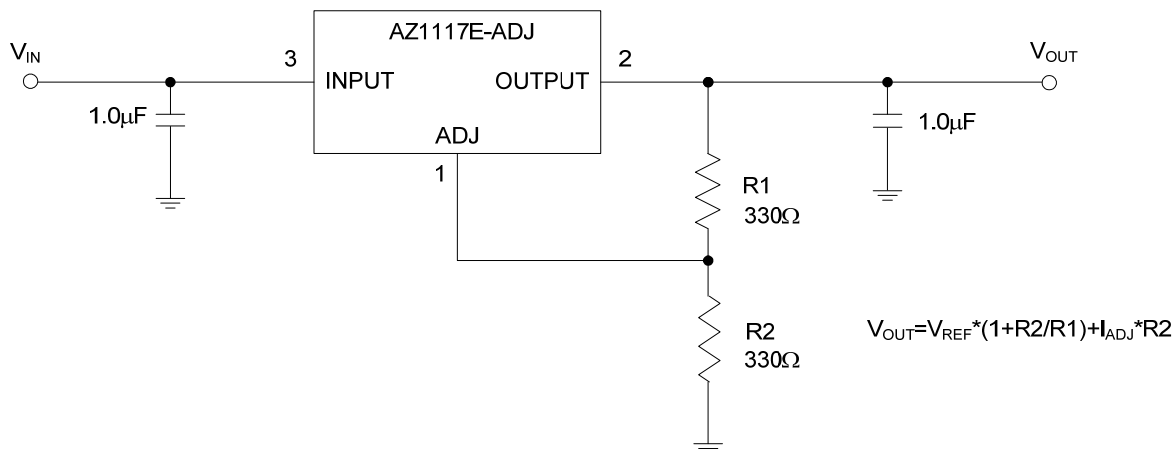

Typical Applications Circuit (Cont. Note 4)

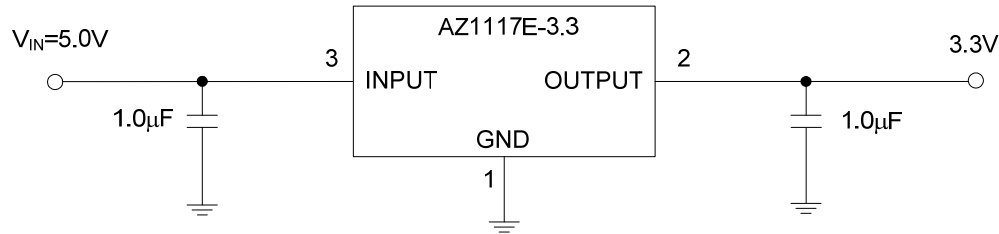

Note 4: The AZ1117E is compatible with Low ESR ceramic capacitor. A minimum of 1.0µF input and output capacitors are required. The ESR of the output capacitors must be less than 1.5Ω. Close to the OUTPUT pin, it is not recommended to use a capacitor smaller than 0.68µF in parallel with output capacitor. When the output capacitor parallels 0.1µF capacitor, the 0.1µF capacitor must be away from the OUTPUT pin, the distance is no less than 5mm.

Pin Descriptions

Pin Number	Pin Name	Function
1	ADJ/GND	Adjustable pin or ground pin
2	OUTPUT	Regulator output pin
3	INPUT	Supply voltage pin

Absolute Maximum Ratings (Note 5)

Symbol	Parameter	Rating	Unit
V_{IN}	Power Supply Voltage	16	V
T_J	Operating Junction Temperature Range	+150	°C
T_{STG}	Storage Temperature Range	-65 to +150	°C
T_{LEAD}	Lead Temperature (Soldering, 10sec)	+260	°C
θ_{JA}	Thermal Resistance (Junction to Ambient) (Note 6)	65	°C/W
-	ESD (Machine Model)	200	V
-	ESD (Human Body Model)	2000	V

Notes: 5. Stresses greater than those listed under "Absolute Maximum Ratings" may cause permanent damage to the device. These are stress ratings only, and functional operation of the device at these or any other conditions beyond those indicated under "Recommended Operating Conditions" is not implied. Exposure to "Absolute Maximum Ratings" for extended periods may affect device reliability.
6. Chip is soldered to 200mm² (16mm*12.5mm) copper (top side solder mask) on 2oz.2 layers FR-4 PCB with 8*0.5mm vias.

Recommended Operating Conditions

Symbol	Parameter	Min	Max	Unit
V_{IN}	Supply Voltage	-	13	V
T_J	Operating Junction Temperature Range	-40	+125	°C

Electrical Characteristics (@ $V_{IN} = V_{OUT} + 1.5V$, $C_{IN} = 1.0\mu F$ (Ceramic), $C_{OUT} = 1.0\mu F$ (Ceramic), Typical $T_A = +25^\circ C$, **Bold** typeface applies over $-40^\circ C \leq T_J \leq +125^\circ C$ ranges, unless otherwise specified.)

Symbol	Parameter	Conditions	Min	Typ	Max	Unit	
V_{REF}	Reference Voltage	$V_{OUT} + 1.5V \leq V_{IN} \leq 12V$, $I_{OUT} = 10mA$	1.238	1.250	1.262	V	
			98%*V_{OUT}	V_{OUT}	102%*V_{OUT}	V	
V_{OUT}	Output Voltage (Fixed Versions)	For 1.2V, $V_{OUT} + 1.5V \leq V_{IN} \leq 12V$, $I_{OUT} = 10mA$	98%* V_{OUT}	V_{OUT}	102%* V_{OUT}	V	
			96%*V_{OUT}	V_{OUT}	104%*V_{OUT}	V	
		For 1.5V to 5V, $V_{OUT} + 1.5V \leq V_{IN} \leq 12V$, $I_{OUT} = 10mA$	99%* V_{OUT}	V_{OUT}	101%* V_{OUT}	V	
			98%*V_{OUT}	V_{OUT}	102%*V_{OUT}	V	
V_{DROP}	Dropout Voltage	$I_{OUT} = 1A$	–	1.1	1.3	V	
$I_{OUT(MAX)}$	Maximum Output Current	$1.5V \leq V_{IN} - V_{OUT}$	1	1.3	–	A	
V_{RLOAD}	Load Regulation	$V_{IN} = V_{OUT} + 1.5V$ $1mA \leq I_{OUT} \leq 1A$	–	0.2	0.6	%/A	
V_{RLINE}	Line Regulation	$1.5V \leq V_{IN} - V_{OUT} \leq 10V$, $I_{OUT} = 30mA$	–	0.001	± 0.04	%/V	
I_Q	Quiescent Current	For Fixed Voltage Version, $I_{OUT} = 0$	–	3.5	6	mA	
–	Minimum Load Current	For ADJ Version, $1.5V \leq V_{IN} - V_{OUT} \leq 10V$	–	2	5	mA	
I_{ADJ}	Adjustable Pin Current	–	–	45	90	μA	
–	Adjustable Pin Current Change	$1.5V \leq V_{IN} - V_{OUT} \leq 10V$	–	0.2	5	μA	
PSRR	Power Supply Rejection Ratio	Ripple 1.0 Vp-p $V_{IN} = V_{OUT} + 2V$, $I_{OUT} = 100mA$	f = 120Hz	–	70	–	dB
			f = 1kHz	–	70	–	
$\frac{\Delta V_{OUT}}{\Delta T} / V_{OUT}$	Output Voltage Temperature Coefficient	$I_{OUT} = 30mA$	–	± 30	–	ppm/ $^\circ C$	
V_{NOISE}	RMS Output Noise	$10Hz \leq f \leq 100kHz$, No Load	–	0.003	–	%	
T_{OTSD}	Thermal Shutdown Temperature	–	–	+170	–	$^\circ C$	
T_{HYOTSD}	Thermal Shutdown Hysteresis	–	–	+20	–	$^\circ C$	
θ_{JC}	Thermal Resistance (Junction to Case)	SOT-223	–	40	–	$^\circ C/W$	

Performance Characteristics

Line Regulation vs. Temperature

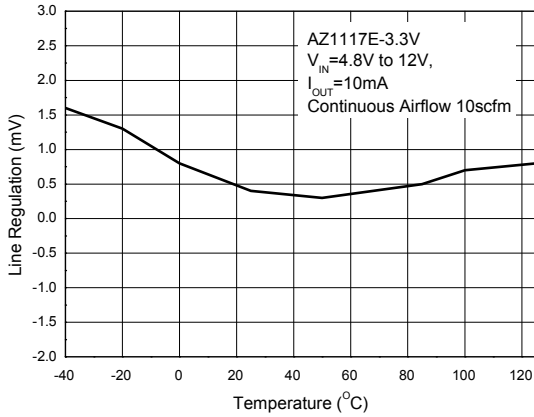

Load Regulation vs. Temperature

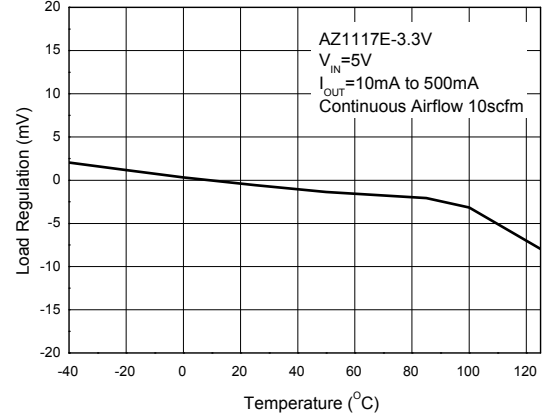

Reference Voltage vs. Temperature

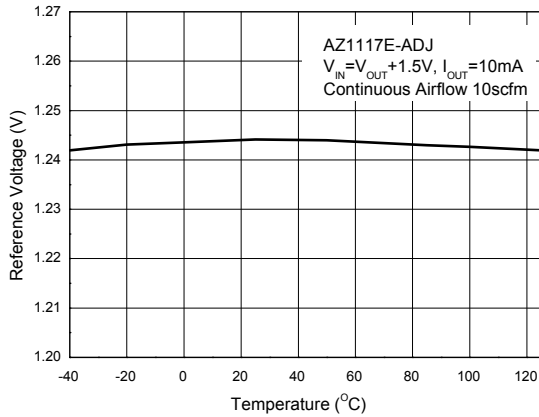

Output Voltage vs. Temperature

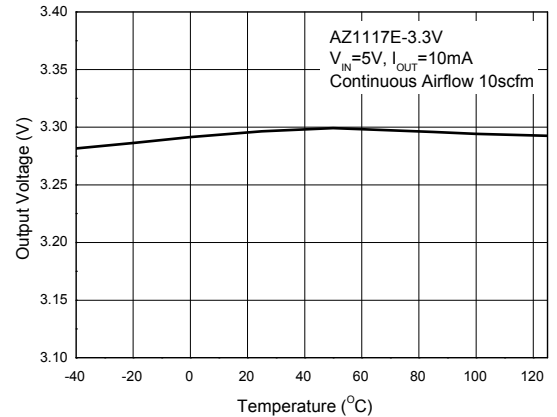

Minimum Load Current vs. Temperature

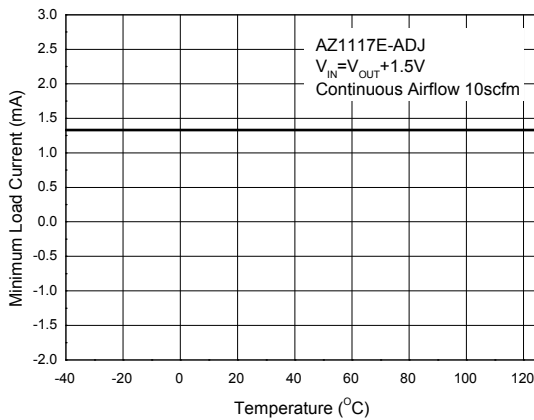

Adjust Pin Current vs. Temperature

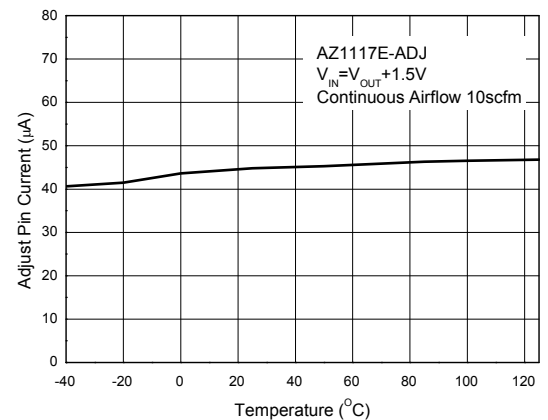

Performance Characteristics (Cont.)

Dropout Voltage vs. Output Current

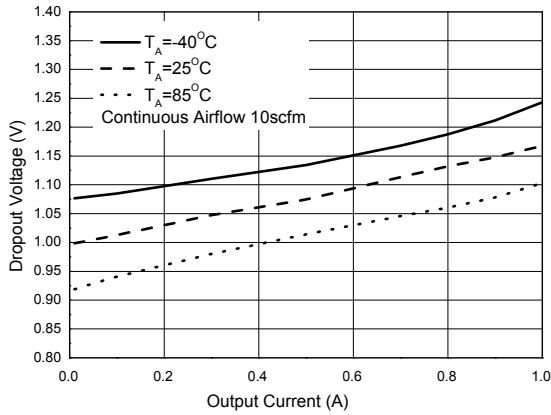

Dropout Voltage vs. Temperature

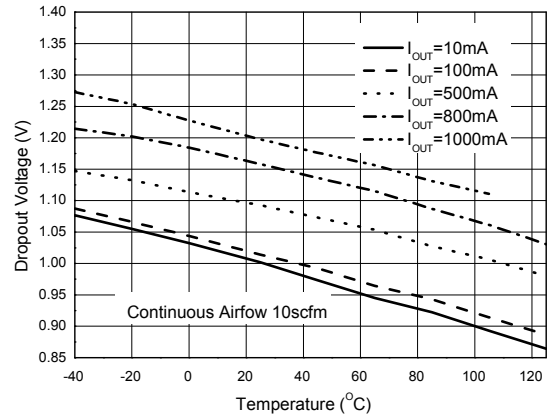

Output Voltage vs. Output Current

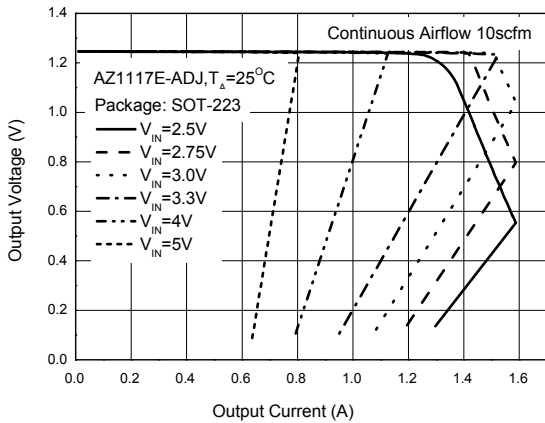

Output Voltage vs. Output Current

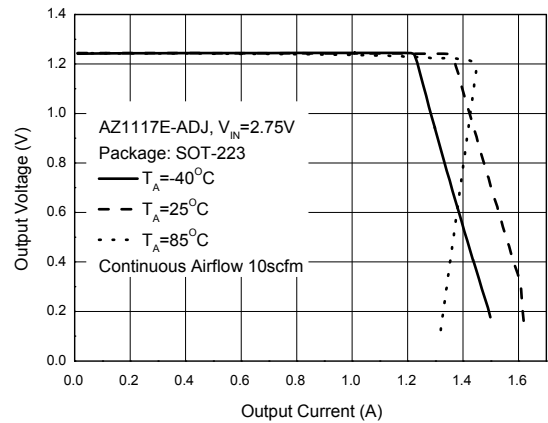

PSRR vs. Frequency

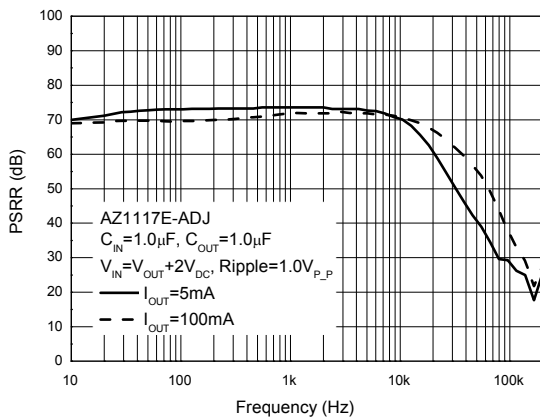

Current Limit vs. Temperature

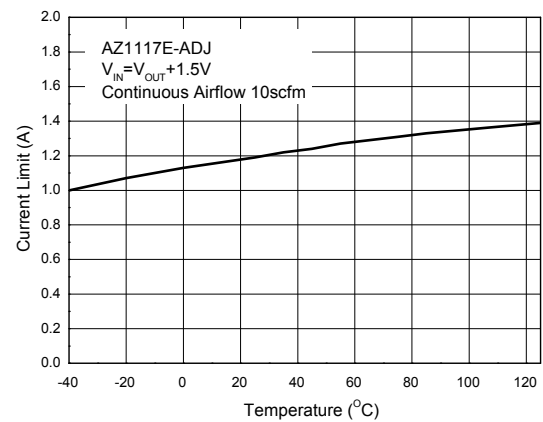

Performance Characteristics (Cont.)

Load Transient Response

(AZ1117E-ADJ, $V_{IN}=5V$, $V_{OUT}=3.3V$,

$C_{IN}=1.0\mu F$, $C_{OUT}=1.0\mu F$)

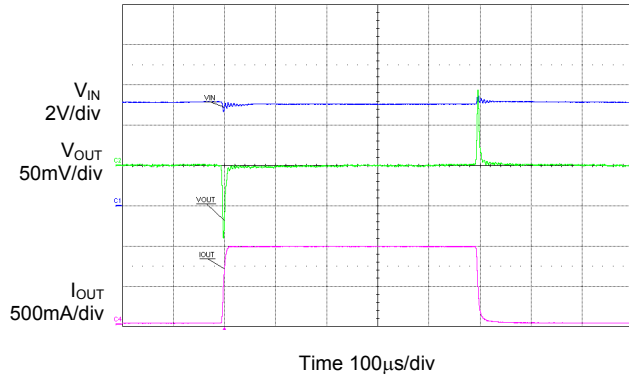

NEW PRODUCT

Ordering Information

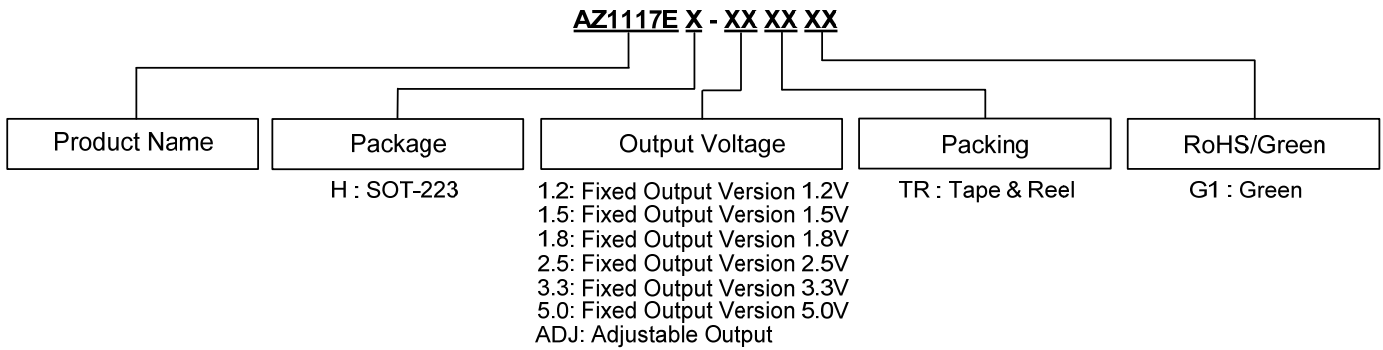

Package	Temperature Range	Part Number	Marking ID	Packing
SOT-223	-40 to +125°C	AZ1117EH-1.2TRG1	GH23F	4000/Tape & Reel
		AZ1117EH-1.5TRG1	GH27F	4000/Tape & Reel
		AZ1117EH-1.8TRG1	GH18G	4000/Tape & Reel
		AZ1117EH-2.5TRG1	GH23G	4000/Tape & Reel
		AZ1117EH-3.3TRG1	GH27G	4000/Tape & Reel
		AZ1117EH-5.0TRG1	GH18H	4000/Tape & Reel
		AZ1117EH-ADJTRG1	GH23H	4000/Tape & Reel

Marking Information

SOT-223 Series

(Top View)

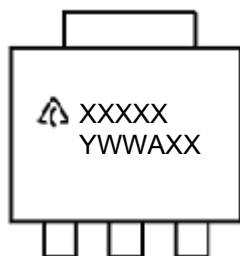

First Line: Logo and Marking ID
(See Ordering Information)
Second Line: Date Code
Y: Year
WW: Work Week of Molding
A: Assembly House Code
XX: 7th and 8th Digits of Batch Number

Package Outline Dimensions (All dimensions in mm(inch).)

(1) Package Type: SOT-223

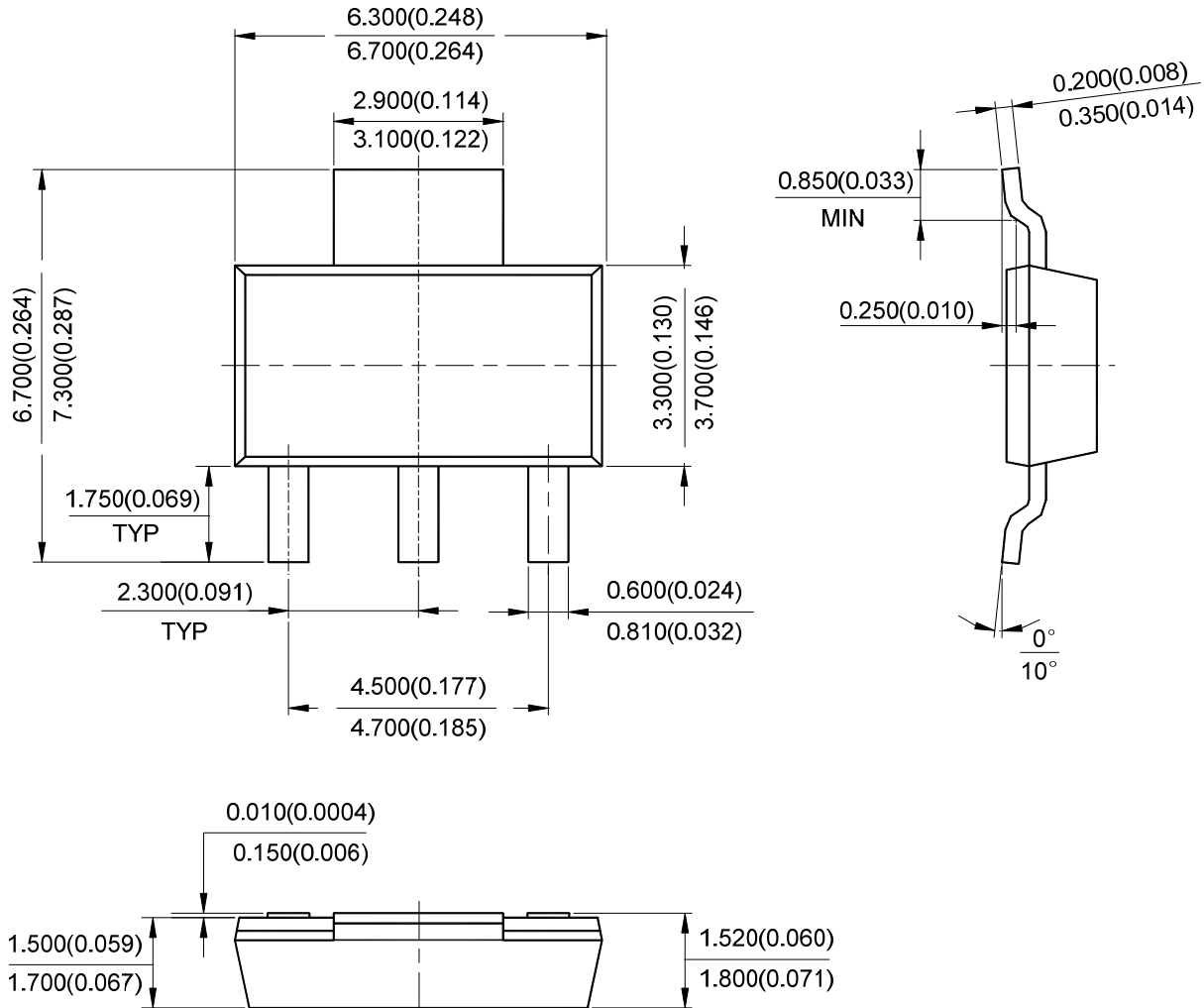

NEW PRODUCT

Suggested Pad Layout

(1) Package Type: SOT-223

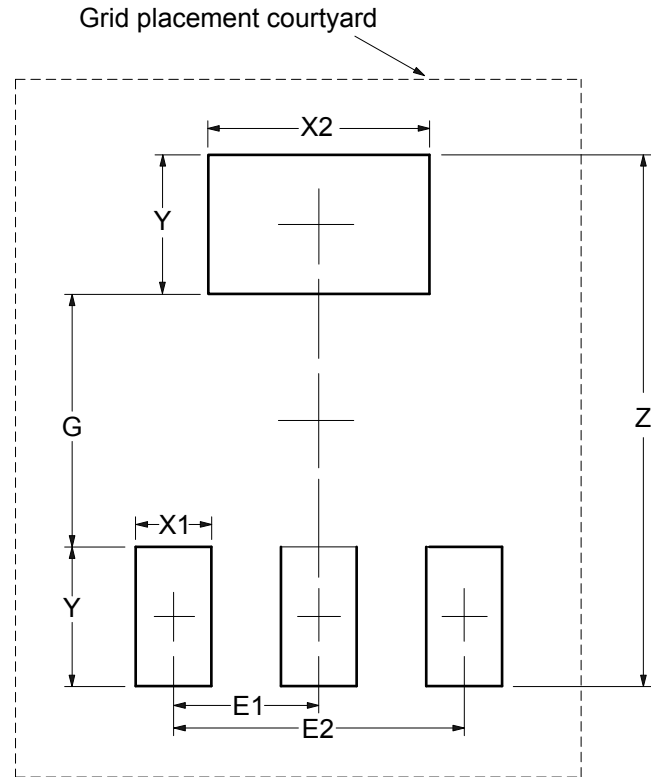

Dimensions	Z (mm)/(inch)	G (mm)/(inch)	X1 (mm)/(inch)	X2 (mm)/(inch)	Y (mm)/(inch)	E1 (mm)/(inch)	E2 (mm)/(inch)
Value	8.400/0.331	4.000/0.157	1.200/0.047	3.500/0.138	2.200/0.087	2.300/0.091	4.600/0.181

IMPORTANT NOTICE

DIODES INCORPORATED MAKES NO WARRANTY OF ANY KIND, EXPRESS OR IMPLIED, WITH REGARDS TO THIS DOCUMENT, INCLUDING, BUT NOT LIMITED TO, THE IMPLIED WARRANTIES OF MERCHANTABILITY AND FITNESS FOR A PARTICULAR PURPOSE (AND THEIR EQUIVALENTS UNDER THE LAWS OF ANY JURISDICTION).

Diodes Incorporated and its subsidiaries reserve the right to make modifications, enhancements, improvements, corrections or other changes without further notice to this document and any product described herein. Diodes Incorporated does not assume any liability arising out of the application or use of this document or any product described herein; neither does Diodes Incorporated convey any license under its patent or trademark rights, nor the rights of others. Any Customer or user of this document or products described herein in such applications shall assume all risks of such use and will agree to hold Diodes Incorporated and all the companies whose products are represented on Diodes Incorporated website, harmless against all damages.

Diodes Incorporated does not warrant or accept any liability whatsoever in respect of any products purchased through unauthorized sales channel. Should Customers purchase or use Diodes Incorporated products for any unintended or unauthorized application, Customers shall indemnify and hold Diodes Incorporated and its representatives harmless against all claims, damages, expenses, and attorney fees arising out of, directly or indirectly, any claim of personal injury or death associated with such unintended or unauthorized application.

Products described herein may be covered by one or more United States, international or foreign patents pending. Product names and markings noted herein may also be covered by one or more United States, international or foreign trademarks.

This document is written in English but may be translated into multiple languages for reference. Only the English version of this document is the final and determinative format released by Diodes Incorporated.

LIFE SUPPORT

Diodes Incorporated products are specifically not authorized for use as critical components in life support devices or systems without the express written approval of the Chief Executive Officer of Diodes Incorporated. As used herein:

A. Life support devices or systems are devices or systems which:

1. are intended to implant into the body, or
2. support or sustain life and whose failure to perform when properly used in accordance with instructions for use provided in the labeling can be reasonably expected to result in significant injury to the user.

B. A critical component is any component in a life support device or system whose failure to perform can be reasonably expected to cause the failure of the life support device or to affect its safety or effectiveness.

Customers represent that they have all necessary expertise in the safety and regulatory ramifications of their life support devices or systems, and acknowledge and agree that they are solely responsible for all legal, regulatory and safety-related requirements concerning their products and any use of Diodes Incorporated products in such safety-critical, life support devices or systems, notwithstanding any devices- or systems-related information or support that may be provided by Diodes Incorporated. Further, Customers must fully indemnify Diodes Incorporated and its representatives against any damages arising out of the use of Diodes Incorporated products in such safety-critical, life support devices or systems.

Copyright © 2014, Diodes Incorporated

www.diodes.com

Mouser Electronics

Authorized Distributor

Click to View Pricing, Inventory, Delivery & Lifecycle Information:

Diodes Incorporated:

[AZ1117EH-1.8TRG1](#) [AZ1117EH-ADJTRG1](#) [AZ1117EH-1.5TRG1](#) [AZ1117EH-5.0TRG1](#) [AZ1117EH-1.2TRG1](#)
[AZ1117EH-2.5TRG1](#) [AZ1117EH-3.3TRG1](#)