

---

# 20W Epistar 45mil Chip

## High Power LED

**White: LEDE-P20B-DH-White**

**Warm White: LEDE-P20B-DWH**

### Features

- Long operating life
- Highest Luminous flux
- Wide range of colours:2500K-25000K
- Chip size: Epistar 45\*45mil
- More energy efficient than incandescent and most halogen lamps
- Low voltage DC operated
- Instant light (less than 100ns )
- Fully dimmable
- No UV
- Superior ESD protection
- RoHS compliant

### Applications

- Fiber optic alternative/ Decorative / Entertainment
- Mini-accent/Up lighters/Down lighters/Orientation
- Indoor/Outdoor commercial and Residential Architectural
- Cove/Under shelf/Task
- Bollards/Security/Garden
- Portable (flashlight, bicycle)
- Edge-lit signs (Exit, point of sale)
- Automotive Exit (Stop-Tail-Turn,CHMSL, Mirror Side Repeat)
- Traffic signaling / Beacons / Rail-Crossing and Wayside

### Typical Electrical & Optical Characteristics ( Ta = 25°C )

Item	Symbol	Condition	Min.	Typ.	Max.	Unit
Forward Voltage	VF	IF=700mA	32	--	36	V
Reverse Current	IR	VR=50V	--	--	80	uA
50% Power Angle	2θ1/2	IF=700mA	110	--	140	deg
Luminous Intensity (White)	φV	IF=700mA	1800		2000	lm
Recommend Forward Current	IF	--	--	0.6	--	A
Chromaticity (White)	Tc	IF=700mA	6000		7000	k
Chromaticity (Warm White)	Tc	IF=700mA	2700		3800	k

The sample delivers goods data

Item	Symbol	Condition	Min.	Avg.	Max.	Unit
Luminous Intensity	φV	IF=700mA				lm
50% Power Angle	2θ1/2					deg
Forward Voltage	VF					v
Chromaticity	Tc					k
White Color Region	--					
ChromaticityCoordinates	X=--			Y=--		

**Notes:**

1. Tolerance of measurement of forward voltage ±0.2V.
2. Tolerance of measurement of peak Wavelength ±2.0nm.
3. Tolerance of measurement of luminous intensity ±15%.

### Absolute Maximum Ratings (Ta = 25°C)

Item	Symbol	Absolute Maximum Rating	Unit
Forward Current	IF	700	mA
Peak Forward Current*	IFP	1400	mA
Reverse Voltage	VR	50	V
Power Dissipation	PD	20	W
Electrostatic discharge	ESD	±4500	V
Operation Temperature	TOPR	-30~+80	°C
Storage Temperature	TSTG	-40~+100	°C
Lead Soldering Temperature*	TSOL	Max. 260°C for 3sec Max.	

\*IFP Conditions : Pulse Width ≤ 10msec duty ≤ 1/10

\* All high power emitter LED products mounted on aluminum metal-core printed circuit board, can be lighted directly, but we do not recommend lighting the high power products for more than 5 seconds without a appropriate heat dissipation equipment.

\*Please don't add or change wires, while LEDS is running

\* The LED of this a series can lead the heat reflux of 250 Celsius degrees Han but be free from damage.

**Typical Electrical/Optical Characteristics Curves (Ta=25° Unless Otherwise Noted)**

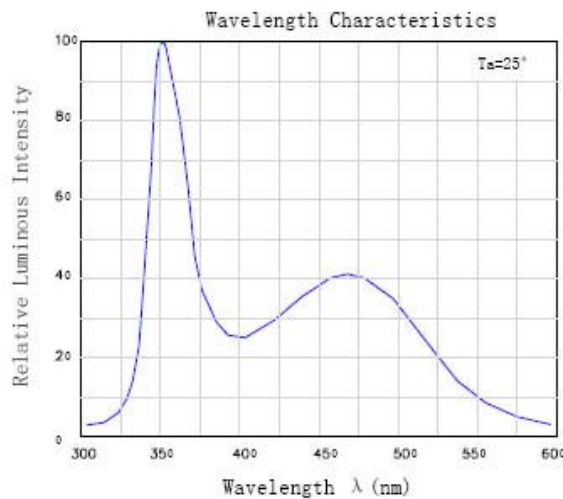
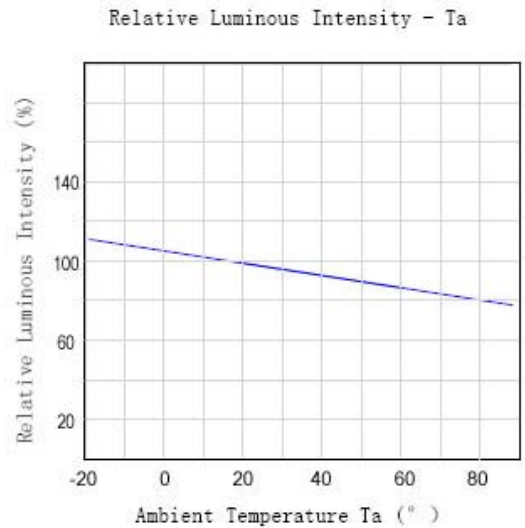
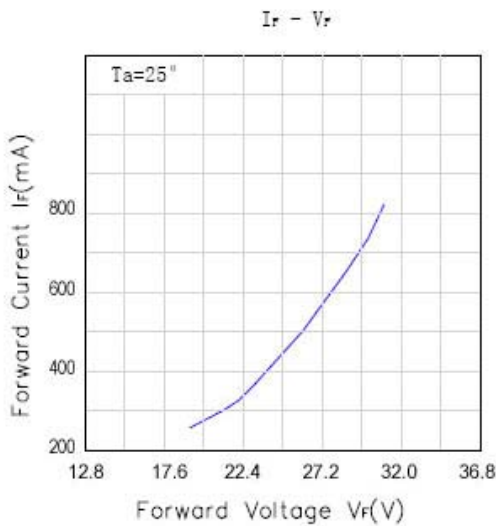
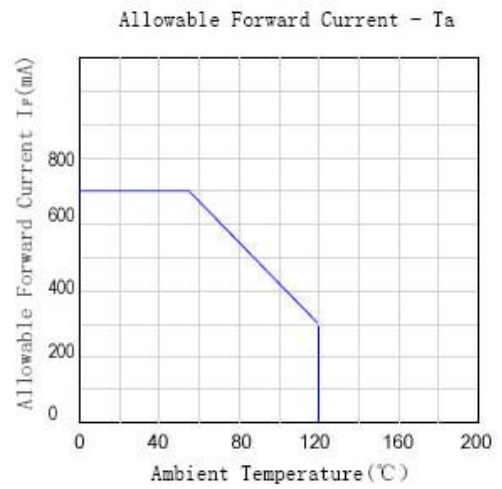
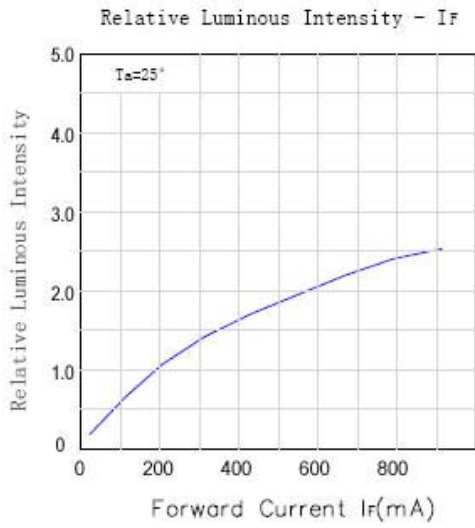

## Reflow Soldering Characteristics

(回流焊特性)

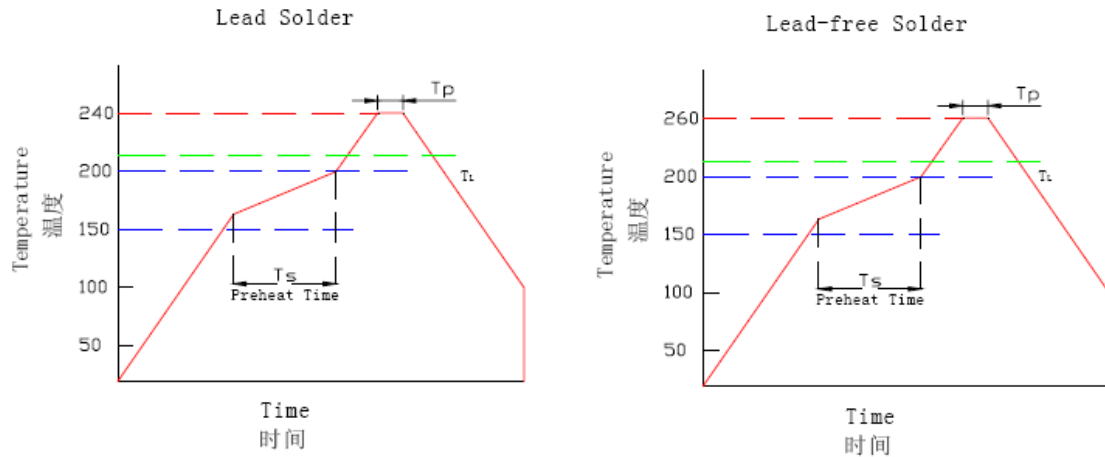

## Soldering Condition (焊接条件)

Reflow Soldering 回流焊接		Hand Soldering 手工焊接	
	Lead Solder	Lead-free Sol	
Profile Feature 平均升温速度	2-3 °C/s	2-3 °C/s	
Pre-heat(Ts) 预热	120-150°C	150-180°C	
Perheat time(Ts) 预热时间	60-120s	120s Max	
Temperature(TL) 温度	217°C	217°C	Temperature 温度
Time Maintained above 高于 TL 温度的时间	60-90s	60-90s	350°C Max
Peak Temperature(Tp) 峰值温度	240 ± 5°C	260°C	
Perk Time (Tp) 实际峰值温度内的时间	20s	20s	Time 焊接时间
Soldering Time Condition 焊接时间条件	5sec Max	5sec Max	3 sec (一次性完成)
Ramp-Down Rate 降温速度	3-5 °C/s	3-5 °C/s	

Recommend The use of environmentally friendly **Lead-free Solder**  
建议使用对环境无害的无铅焊料

## Radiation Pattern

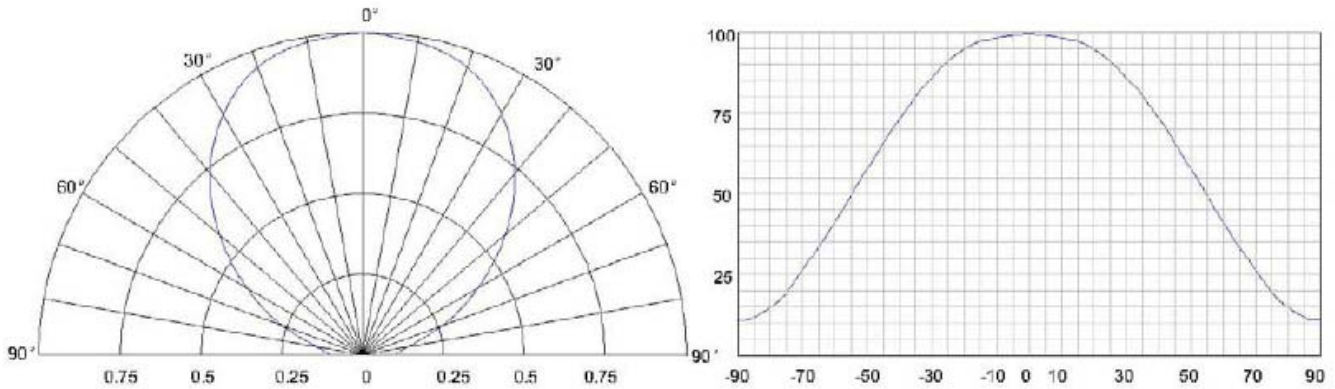

## Package Dimensions (unit:mm)

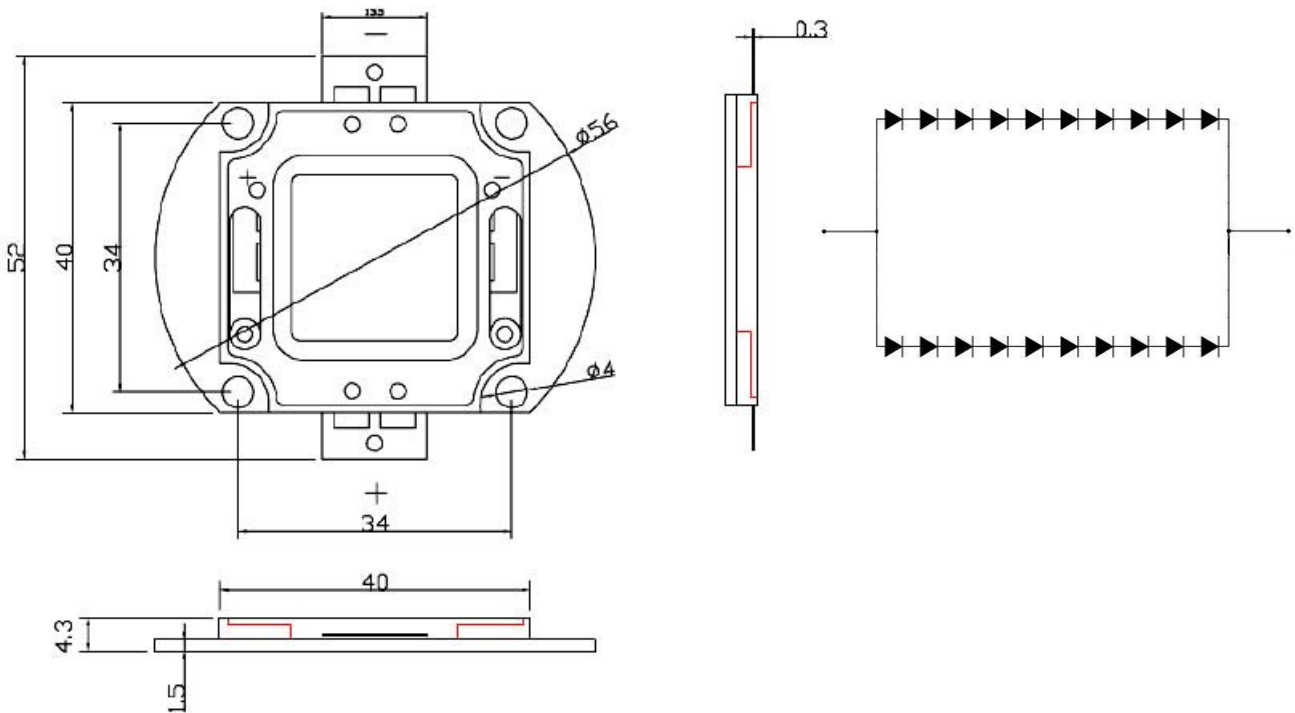

### Notes:

1. All dimensions are in millimeters.
2. Tolerance is  $\pm 0.25\text{mm}$  unless otherwise noted.
3. Protruded resin under flange is 1.0mm max.
4. Lead spacing is measured where the leads emerge from the package.
5. Specifications are subject to change without notice.

## Note the use of high-power LED

### Product Protection

LED is the electrostatic sensitive devices, so the product storage, transportation, application process, paying particular attention to static electricity, electromagnetic waves, and together with the necessary anti-static measures

### Safety Precautions

Harmful substances such as devices include GaAs, GaAs dust and fumes are toxic, this product can not be broken, cutting or grinding, not with chemicals to dissolve.

### **Design and Application**

1. in the ratings to be used within the operating LED current limit function of the resistor. How much resistance will have to refer to the specific product specifications required to calculate the rated current plus that.
2. LED to be used in parallel mode, each LED channel by adding resistors are required, must not be led directly to multiple parallel.
3. circuits shall be designed to note: When the LED goes out to prohibit reverse voltage.
4. circuitry required to design note: the lights, turn off the lights when you prevent the instantaneous voltage.
5. solder direction (electrode direction) to be orthogonal with the direction of PCB.
6. high temperature will reduce its performance and reliability, please stay away from heat sources.

### **Cleaning**

1. avoid the use of non-designated chemical solvents to clean the LED.  
For example: trichloroethene, chlorosilanes, acetone, difluoro esters.
2. If necessary cleaning carried out at room temperature, and not more than 1 minute.
3. When using any cleaning a chemical solvent to be especially careful, because some chemical solvents will damage the gel surface.
4. recommend the use of isopropyl alcohol or pure water (not tap water) for cleaning.
5. If using pure water, then immediately after cleaning dehumidifying, forced drying.

### **Save**

1. before unpacking, LED should be stored in 30 °C / 90% RH or less environment. After opening the package, LED should be placed in 30 °C / 70% RH or below the environment
2. effective use for 1 year, after opening in 168H (7 days) of the exhausted.
3. If the use of desiccant fade or expired, the need to dry and roast: 60 ± 6 °C / 24H.
4. LED James Gray lens easily, you need to do a good job related to dust control measures

### **Pick and place**

Grasping LED can only touch on the body frame, tweezers, a tool can not put pressure on the lens, not to stamp. stab or push the lens.

### **Heat treatment**

When the LED current drive is too large the  $T_j$  (junction temperature) will exceed its limit, which can cause serious shorten the life of LED, the heat treatment measures to effectively reduce the thermal resistance applications. More common practice is to install the LED package device PCB board in the metal matrix. 1W LED products require heat the metal substrate surface area of at least 30 C m<sup>2</sup> (3W products recommended above 80 C m<sup>2</sup>), and its thermal conductivity is higher than 2.0W/mK. LED and thermal conductivity of metal substrate by a better combination of thermal plastic, thermal requirements Coefficient is higher than 1.0W/mK. thickness of less than 100um.

## **Warranty**

All products manufactured by WAYJUN TECHNOLOGY are under warranty regarding defective materials for a period of two years from the date of delivery to the original purchaser.

## **Copyright**

Copyright 2012, by ShenZhen Wayjun Technology Co.,Ltd. All rights are reserved. ShenZhen Wayjun Technology Co.,Ltd reserves the right to make improvements to the products described in this manual at any time without notice.

## **Trademark**

The names used for identification only may be registered trademarks of their respective companies.