

REVISION RECORD			
REV/ECO	DESCRIPTION	DRFT	DATE

- Notes:
1. Pitch: 3.5mm , Poles: 2-24P
 2. Rated voltage/current: UL 300V/8A
VDE 250V/7A
 3. Operation temperatures: -40°C ~ +105°C
 4. Withstanding Voltage: AC2000V/1Min
 5. Insulation Resistance: 5000MΩ /DC1000V
 6. Wire Range: 28~16AWG, 0.5-1.5mm²
 7. Max. Torque Value: M2, 2.04kgf.cm (1.77lb. in)
 8. Undimensioned Tolerances:

Pitch range in mm	Nominal dimension range in mm	
over 6	over 30	—
to 10	to 60	∩
to 15	to 100	∩
to 24	to 150	∩
to 30	to 150	∩
to 60	to 150	∩
to 100	to 150	∩
to 150	to 150	∩
±0.10	±0.25	±0.2 ±0.3 ±0.5 ±0.7 ±1

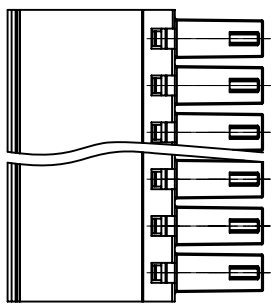
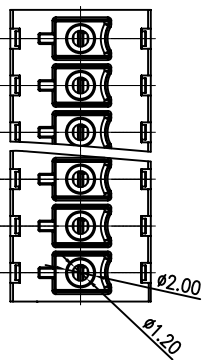
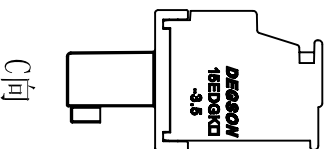
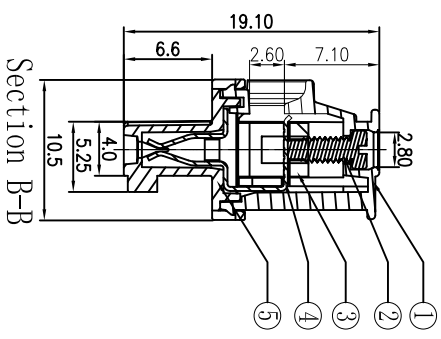
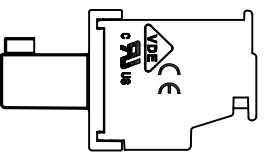
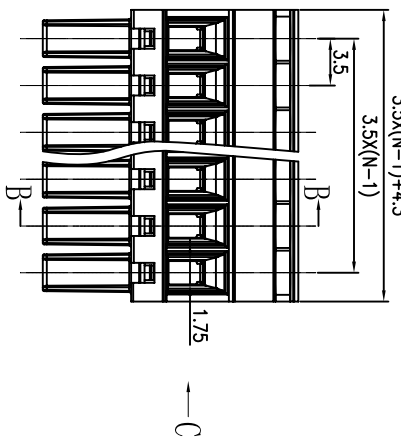
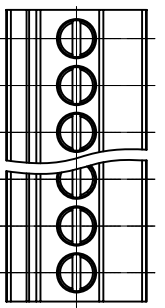

ITEM	NAME OF PART	NO. OF PART	Q'TY	MATERIAL	NOTES
5	15EDGKA/B-3.5-100A-Cover	1033C0YXXE(H)	1	PA66	UL94V-0
4	15EDGKA/B-100A-Clamp	1033B00020(H)	XX	Phosphor bronze	SnCe
3	15EDGK Cage	X000000010(H)	XX	Brass	Ni Plated
2	15EDG Screw-M2.0	S000001360(H)	XX	Steel	Cr ³⁺ Zn
1	15EDGKA/B-3.5-100A-Housing	1033A0YXXE(H)	1	PA66	UL94V-0

DETACHED LISTS			
MM	(INCH)	DATE	DATE
0.1 ±	±	04/11/09*	
.00 ±	±		
.000 ±	±		

THIRD ANGLE PROJECTION		SCALE : 1:1	
FINISH :		DRAWING NO. 15EDGKB-3.5-E100	
G.E :		/PART NO.	
MATERIAL :		DO NOT SCALE DRAWING	
C.E :		SHEET 1	
APPR :		OF 1	
CHKD :		SIZE A3	
DATE :		REV 10	
		REV/09/09*	

DEGSON 宁波高正电子有限公司
DEGSON ELECTRONICS CO., LTD.

NAME 15EDGKB-3.5-XXP-1Y-100A(H)