

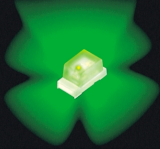
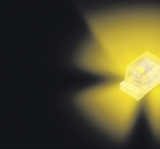
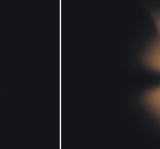

High Brightness Type Mini-molded chip LEDs

SML-51 * Series

Package Size (mm)	Green	Yellow		Orange		Red	
	AlGaInP on GaAs						
	570nm	590nm		611nm		630nm	
1608 (0603) 1.6×0.8 t=0.55							
	SML-512MW	SML-511WW	SML-512WW	SML-511DW	SML-512DW	SML-511UW	SML-512UW

Absolute Maximum Ratings (Ta=25°C)

Part No.	Emitting color	Power dissipation Pd (mW)	Forward current IF (mA)	Peak forward current I _{FP} (mA)	Reverse voltage VR (V)	Operating temperature T _{opr} (°C)	Storage temperature T _{stg} (°C)
SML-512MW	Green	65	25	100*2	5	-30 to +85	-40 to +85
SML-511WW	Yellow	62		60*1	4	-30 to +85	-40 to +85
SML-512WW		75	100*2	5	-40 to +100	-40 to +100	
SML-511DW	Orange	62	25	60*1	4	-30 to +85	-40 to +85
SML-512DW		75	30	100*2	5	-40 to +100	-40 to +100
SML-511UW	Red	62	25	60*1	4	-30 to +85	-40 to +85
SML-512UW		75	30	100*2	5	-40 to +100	-40 to +100

*1 I_{FP} measured under duty ≤1/5, pulse width ≤1ms.
*2 I_{FP} measured under duty 1/10, 1kHz

External Dimensions (Unit : mm)

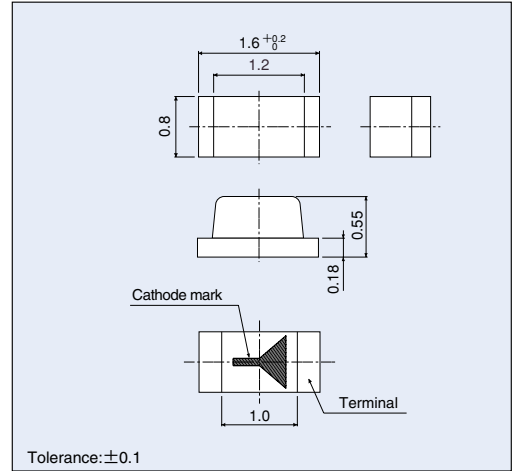

Electrical Optical Characteristics (Ta=25°C)

Part No.	Resin Color	Forward voltage VF		Reverse current IR		Light wavelength		Brightness Iv			
		Typ. (V)	IF (mA)	Max. (μA)	VR (V)	Peak λp (nm)	Half-wave Δλ (nm)	IF (mA)	Min. (mcd)	Typ. (mcd)	IF (mA)
SML-512MW	Milky White	2.1	20	100	5	570	18	20	14	40	20
SML-511WW				100	4	590	15		22	63	
SML-512WW		10	5	611	16	36	63				
SML-511DW		100	4			14	40				
SML-512DW		10	5	630	18	22	63				
SML-511UW		100	4			14	40				
SML-512UW	10	5	22	63							

Directivity

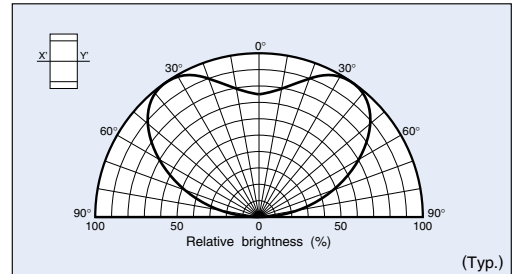

Recommended Pad Layout

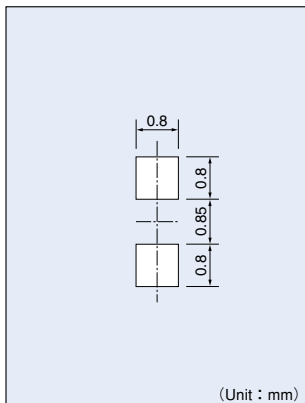

The recommended thickness of the screen mask for soldering is between 100 and 200 μm. The hole size of the screen mask should be same as the recommended land pattern or smaller.

Packaging Specifications (Unit : mm)

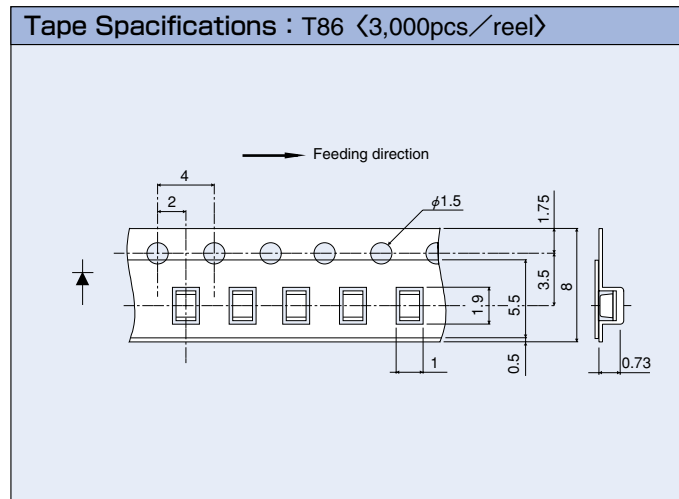

Reel Specifications

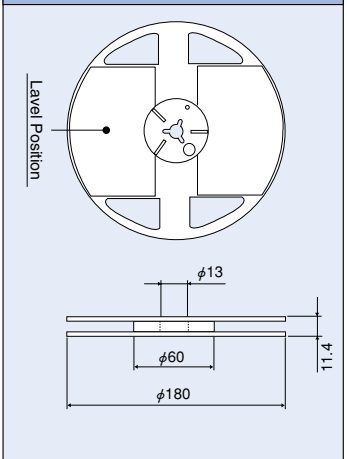

Electrical Characteristic Curves

Forward Current - Forward Voltage

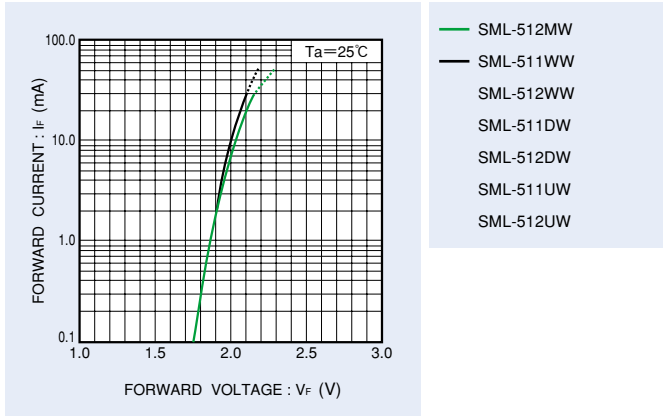

Relative Luminous Intensity - Case Temperature

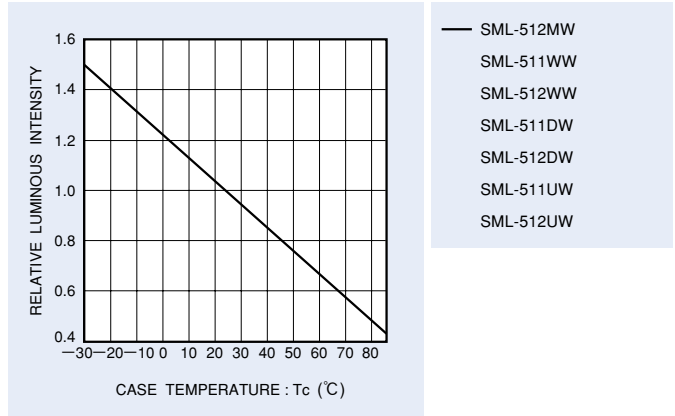

Relative Luminous Intensity - Forward Current

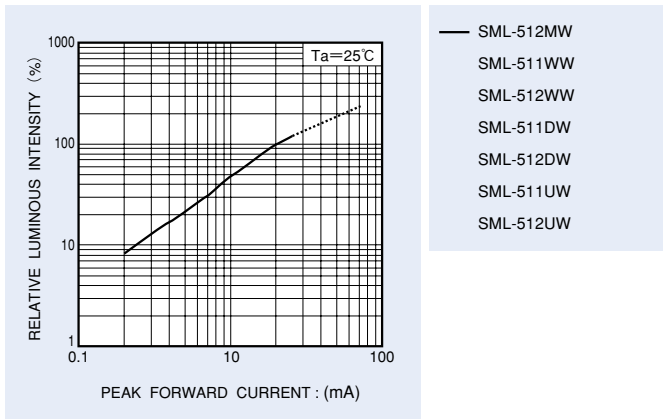

Ratio of Maximum Tolerable Peak Current - Pulse Duration

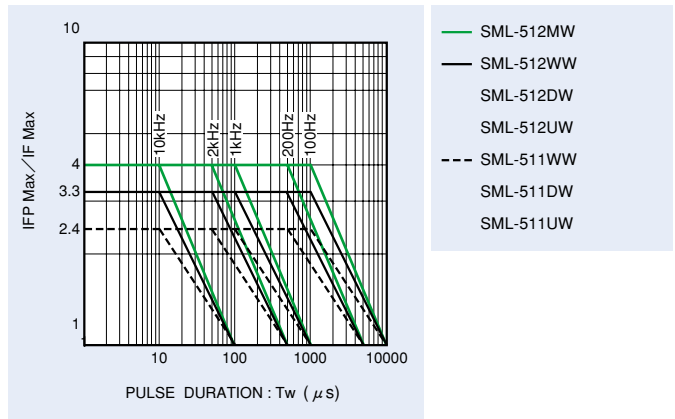

Derating

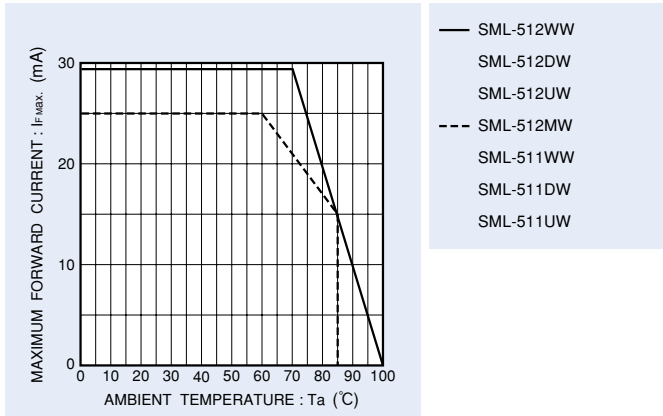

Notes

- No technical content pages of this document may be reproduced in any form or transmitted by any means without prior permission of ROHM CO.,LTD.
- The contents described herein are subject to change without notice. The specifications for the product described in this document are for reference only. Upon actual use, therefore, please request that specifications to be separately delivered.
- Application circuit diagrams and circuit constants contained herein are shown as examples of standard use and operation. Please pay careful attention to the peripheral conditions when designing circuits and deciding upon circuit constants in the set.
- Any data, including, but not limited to application circuit diagrams information, described herein are intended only as illustrations of such devices and not as the specifications for such devices. ROHM CO.,LTD. disclaims any warranty that any use of such devices shall be free from infringement of any third party's intellectual property rights or other proprietary rights, and further, assumes no liability of whatsoever nature in the event of any such infringement, or arising from or connected with or related to the use of such devices.
- Upon the sale of any such devices, other than for buyer's right to use such devices itself, resell or otherwise dispose of the same, no express or implied right or license to practice or commercially exploit any intellectual property rights or other proprietary rights owned or controlled by
- ROHM CO., LTD. is granted to any such buyer.
- Products listed in this document are no antiradiation design.

The products listed in this document are designed to be used with ordinary electronic equipment or devices (such as audio visual equipment, office-automation equipment, communications devices, electrical appliances and electronic toys).

Should you intend to use these products with equipment or devices which require an extremely high level of reliability and the malfunction of which would directly endanger human life (such as medical instruments, transportation equipment, aerospace machinery, nuclear-reactor controllers, fuel controllers and other safety devices), please be sure to consult with our sales representative in advance.

About Export Control Order in Japan

Products described herein are the objects of controlled goods in Annex 1 (Item 16) of Export Trade Control Order in Japan.

In case of export from Japan, please confirm if it applies to "objective" criteria or an "informed" (by MITI clause) on the basis of "catch all controls for Non-Proliferation of Weapons of Mass Destruction.