

# LM60

## 2.7V, SOT-23 or TO-92 Temperature Sensor

### General Description

The LM60 is a precision integrated-circuit temperature sensor that can sense a  $-40^{\circ}\text{C}$  to  $+125^{\circ}\text{C}$  temperature range while operating from a single  $+2.7\text{V}$  supply. The LM60's output voltage is linearly proportional to Celsius (Centigrade) temperature ( $+6.25\text{ mV}/^{\circ}\text{C}$ ) and has a DC offset of  $+424\text{ mV}$ . The offset allows reading negative temperatures without the need for a negative supply. The nominal output voltage of the LM60 ranges from  $+174\text{ mV}$  to  $+1205\text{ mV}$  for a  $-40^{\circ}\text{C}$  to  $+125^{\circ}\text{C}$  temperature range. The LM60 is calibrated to provide accuracies of  $\pm 2.0^{\circ}\text{C}$  at room temperature and  $\pm 3^{\circ}\text{C}$  over the full  $-25^{\circ}\text{C}$  to  $+125^{\circ}\text{C}$  temperature range.

The LM60's linear output,  $+424\text{ mV}$  offset, and factory calibration simplify external circuitry required in a single supply environment where reading negative temperatures is required. Because the LM60's quiescent current is less than  $110\text{ }\mu\text{A}$ , self-heating is limited to a very low  $0.1^{\circ}\text{C}$  in still air in the SOT-23 package. Shutdown capability for the LM60 is intrinsic because its inherent low power consumption allows it to be powered directly from the output of many logic gates.

### Features

- Calibrated linear scale factor of  $+6.25\text{ mV}/^{\circ}\text{C}$
- Rated for full  $-40^{\circ}$  to  $+125^{\circ}\text{C}$  range
- Suitable for remote applications

- Available in SOT-23 and TO-92 packages

### Applications

- Cellular Phones
- Computers
- Power Supply Modules
- Battery Management
- FAX Machines
- Printers
- HVAC
- Disk Drives
- Appliances

### Key Specifications

- Accuracy at  $25^{\circ}\text{C}$ :  $\pm 2.0$  and  $\pm 3.0^{\circ}\text{C}$  (max)
- Accuracy for  $-40^{\circ}\text{C}$  to  $+125^{\circ}\text{C}$ :  $\pm 4.0^{\circ}\text{C}$  (max)
- Accuracy for  $-25^{\circ}\text{C}$  to  $+125^{\circ}\text{C}$ :  $\pm 3.0^{\circ}\text{C}$  (max)
- Temperature Slope:  $+6.25\text{ mV}/^{\circ}\text{C}$
- Power Supply Voltage Range:  $+2.7\text{V}$  to  $+10\text{V}$
- Current Drain @  $25^{\circ}\text{C}$ :  $110\text{ }\mu\text{A}$  (max)
- Nonlinearity:  $\pm 0.8^{\circ}\text{C}$  (max)
- Output Impedance:  $800\text{ }\Omega$  (max)

### Typical Application

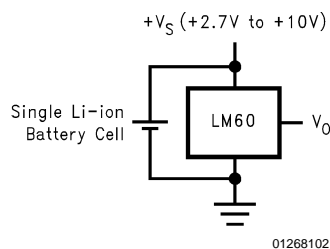

$$V_O = (+6.25\text{ mV}/^{\circ}\text{C} \times T\text{ }^{\circ}\text{C}) + 424\text{ mV}$$

Temperature (T)	Typical $V_O$
$+125^{\circ}\text{C}$	$+1205\text{ mV}$
$+100^{\circ}\text{C}$	$+1049\text{ mV}$
$+25^{\circ}\text{C}$	$+580\text{ mV}$
$0^{\circ}\text{C}$	$+424\text{ mV}$
$-25^{\circ}\text{C}$	$+268\text{ mV}$
$-40^{\circ}\text{C}$	$+174\text{ mV}$

**FIGURE 1. Full-Range Centigrade Temperature Sensor ( $-40^{\circ}\text{C}$  to  $+125^{\circ}\text{C}$ ) Operating from a Single Li-Ion Battery Cell**

### Connection Diagrams

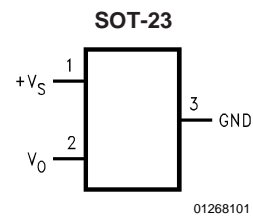

**Top View**  
See NS Package Number MA03B

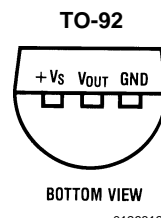

**BOTTOM VIEW**  
See NS Package Number Z03A

## Ordering Information

Order Number	Device Marking	Supplied In	Accuracy Over Specified Temperature Range	Specified Temperature Range	Package Type
LM60BIM3	T6B	1000 Units on Tape and Reel	±3	-25°C ≤ T <sub>A</sub> ≤ +125°C	SOT-23
LM60BIM3X	T6B	3000 Units on Tape and Reel			
LM60CIM3	T6C	1000 Units on Tape and Reel	±4	-40°C ≤ T <sub>A</sub> ≤ +125°C	
LM60CIM3X	T6C	3000 Units on Tape and Reel			
LM60BIZ	LM60BIZ	Bulk	±3	-25°C ≤ T <sub>A</sub> ≤ +125°C	TO-92
LM60CIZ	LM60CIZ	Bulk	±4	-40°C ≤ T <sub>A</sub> ≤ +125°C	

**Absolute Maximum Ratings** (Note 1)

Supply Voltage	+12V to -0.2V
Output Voltage	(+V <sub>S</sub> + 0.6V) to -0.6V
Output Current	10 mA
Input Current at any pin (Note 2)	5 mA
ESD Susceptibility (Note 3) :	
Human Body Model	2500V
Machine Model	
SOT-23	250V
TO-92	200V
Recommended Lead Temperature (Note 4):	
SOT Package:	
Vapor Phase (60 sec)	+215°C
Infrared (15 sec)	+220°C
TO-92 Package (3 sec, dwell time)	+240°C

Storage Temperature	-65°C to +150°C
Maximum Junction Temperature (T <sub>JMAX</sub> )	+125°C

**Operating Ratings**(Note 1)

Specified Temperature Range:	<b>T<sub>MIN</sub> ≤ T<sub>A</sub> ≤ T<sub>MAX</sub></b>
LM60B	-25°C ≤ T <sub>A</sub> ≤ +125°C
LM60C	-40°C ≤ T <sub>A</sub> ≤ +125°C
Supply Voltage Range (+V <sub>S</sub> )	+2.7V to +10V
Thermal Resistance, θ <sub>JA</sub> (Note 5)	
SOT-23	450°C/W
TO-92	180°C/W

**Electrical Characteristics**

Unless otherwise noted, these specifications apply for +V<sub>S</sub> = +3.0 V<sub>DC</sub> and I<sub>LOAD</sub> = 1 μA. **Boldface limits apply for T<sub>A</sub> = T<sub>J</sub> = T<sub>MIN</sub> to T<sub>MAX</sub>** ; all other limits T<sub>A</sub> = T<sub>J</sub> = 25°C.

Parameter	Conditions	Typical (Note 6)	LM60B	LM60C	Units (Limit)
			Limits (Note 7)	Limits (Note 7)	
Accuracy (Note 8)			±2.0	±3.0	°C (max)
			<b>±3.0</b>	<b>±4.0</b>	°C (max)
Output Voltage at 0°C		+424			mV
Nonlinearity (Note 9)			<b>±0.6</b>	<b>±0.8</b>	°C (max)
Sensor Gain (Average Slope)		+6.25	<b>+6.06</b>	<b>+6.00</b>	mV/°C (min)
			<b>+6.44</b>	<b>+6.50</b>	mV/°C (max)
Output Impedance			<b>800</b>	<b>800</b>	Ω (max)
Line Regulation (Note 10)	+3.0V ≤ +V <sub>S</sub> ≤ +10V		<b>±0.3</b>	<b>±0.3</b>	mV/V (max)
	+2.7V ≤ +V <sub>S</sub> ≤ +3.3V		<b>±2.3</b>	<b>±2.3</b>	mV (max)
Quiescent Current	+2.7V ≤ +V <sub>S</sub> ≤ +10V	82	110	110	μA (max)
			<b>125</b>	<b>125</b>	μA (max)
Change of Quiescent Current	+2.7V ≤ +V <sub>S</sub> ≤ +10V	±5.0			μA (max)
Temperature Coefficient of Quiescent Current		0.2			μA/°C
Long Term Stability (Note 11)	T <sub>J</sub> =T <sub>MAX</sub> =+125°C, for 1000 hours	±0.2			°C

**Note 1:** Absolute Maximum Ratings indicate limits beyond which damage to the device may occur. Operating Ratings indicate conditions for which the device is functional, but do not guarantee specific performance limits. For guaranteed specifications and test conditions, see the Electrical Characteristics. The guaranteed specifications apply only for the test conditions listed. Some performance characteristics may degrade when the device is not operated under the listed test conditions.

**Note 2:** When the input voltage (V<sub>I</sub>) at any pin exceeds power supplies (V<sub>I</sub> < GND or V<sub>I</sub> > +V<sub>S</sub>), the current at that pin should be limited to 5 mA.

**Note 3:** The human body model is a 100 pF capacitor discharged through a 1.5 kΩ resistor into each pin. The machine model is a 200 pF capacitor discharged directly into each pin.

**Note 4:** See the URL "<http://www.national.com/packaging/>" for other recommendations and methods of soldering surface mount devices.

**Note 5:** The junction to ambient thermal resistance (θ<sub>JA</sub>) is specified without a heat sink in still air.

**Note 6:** Typicals are at T<sub>J</sub> = T<sub>A</sub> = 25°C and represent most likely parametric norm.

**Note 7:** Limits are guaranteed to National's AOQL (Average Outgoing Quality Level).

**Note 8:** Accuracy is defined as the error between the output voltage and +6.25 mV/°C times the device's case temperature plus 424 mV, at specified conditions of voltage, current, and temperature (expressed in °C).

**Note 9:** Nonlinearity is defined as the deviation of the output-voltage-versus-temperature curve from the best-fit straight line, over the device's rated temperature range.

## Electrical Characteristics (Continued)

**Note 10:** Regulation is measured at constant junction temperature, using pulse testing with a low duty cycle. Changes in output due to heating effects can be computed by multiplying the internal dissipation by the thermal resistance.

**Note 11:** For best long-term stability, any precision circuit will give best results if the unit is aged at a warm temperature, and/or temperature cycled for at least 46 hours before long-term life test begins. This is especially true when a small (Surface-Mount) part is wave-soldered; allow time for stress relaxation to occur. The majority of the drift will occur in the first 1000 hours at elevated temperatures. The drift after 1000 hours will not continue at the first 1000 hour rate.

**Typical Performance Characteristics** To generate these curves the LM60 was mounted to a printed circuit board as shown in *Figure 2*.

**Thermal Resistance  
Junction to Air**

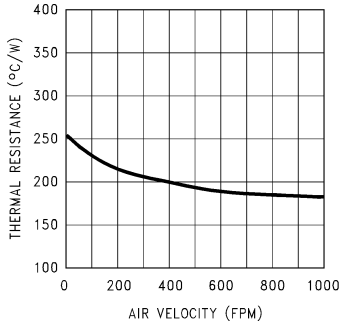

01268103

**Thermal Time Constant**

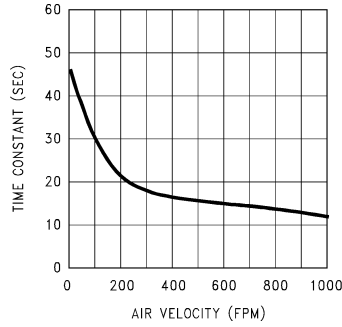

01268104

**Thermal Response in  
Still Air with Heat Sink**

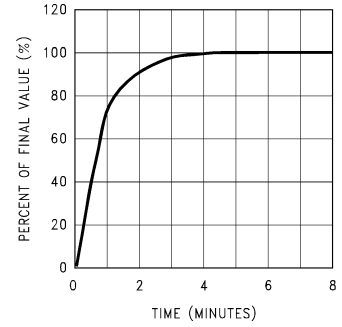

01268105

**Thermal Response  
in Stirred Oil Bath  
with Heat Sink**

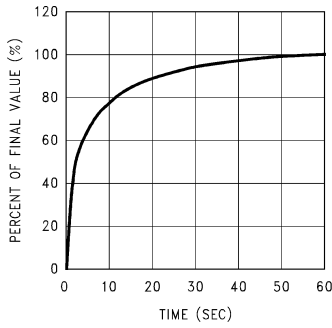

01268106

**Start-Up Voltage  
vs. Temperature**

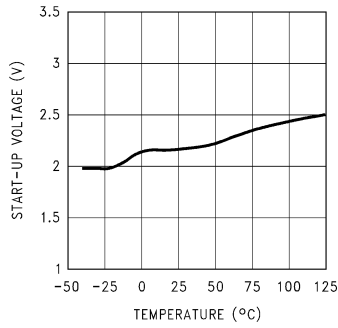

01268107

**Thermal Response in Still  
Air without a Heat Sink**

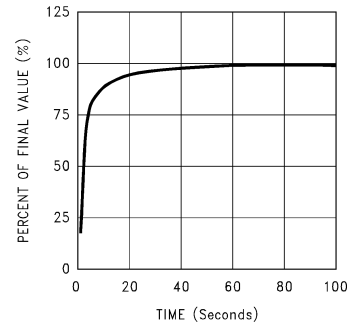

01268108

**Quiescent Current  
vs. Temperature**

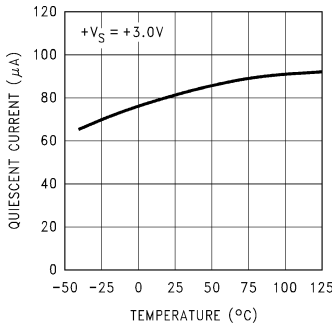

01268109

**Accuracy vs Temperature**

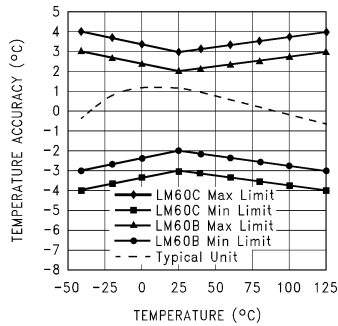

01268110

**Noise Voltage**

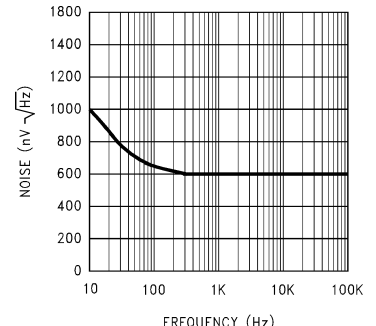

01268111

**Typical Performance Characteristics** To generate these curves the LM60 was mounted to a printed circuit board as shown in *Figure 2*. (Continued)

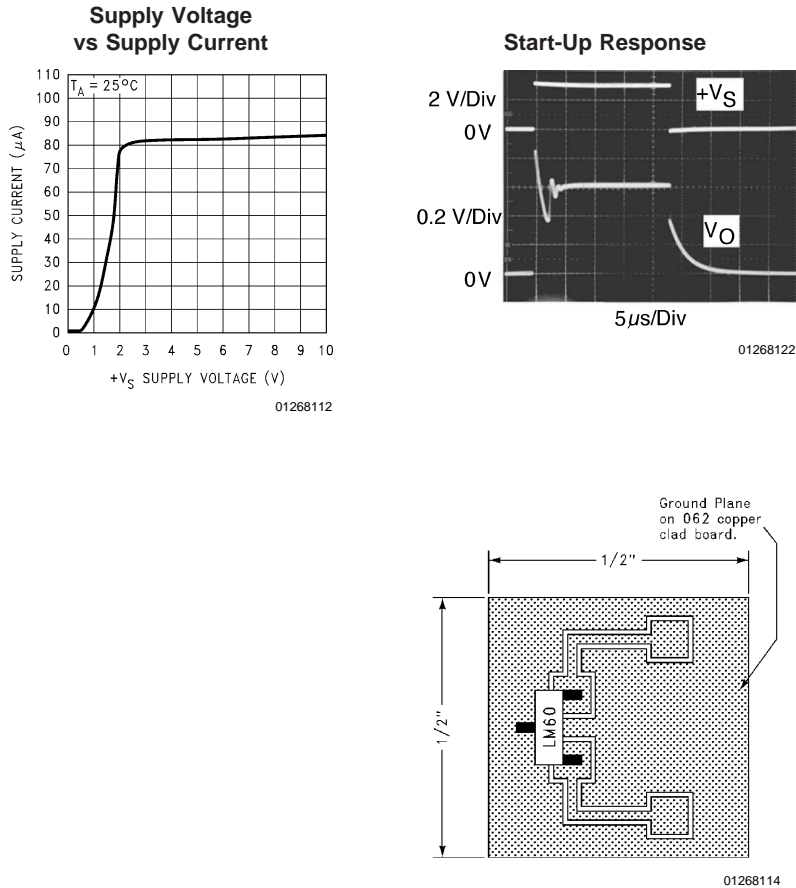

**FIGURE 2. Printed Circuit Board Used for Heat Sink to Generate All Curves. 1/2" Square Printed Circuit Board with 2 oz. Copper Foil or Similar.**

## 1.0 Mounting

The LM60 can be applied easily in the same way as other integrated-circuit temperature sensors. It can be glued or cemented to a surface. The temperature that the LM60 is sensing will be within about  $+0.1^\circ\text{C}$  of the surface temperature that LM60's leads are attached to.

This presumes that the ambient air temperature is almost the same as the surface temperature; if the air temperature were much higher or lower than the surface temperature, the actual temperature of the LM60 die would be at an intermediate temperature between the surface temperature and the air temperature.

To ensure good thermal conductivity the backside of the LM60 die is directly attached to the GND pin. The lands and traces to the LM60 will, of course, be part of the printed circuit board, which is the object whose temperature is being measured. These printed circuit board lands and traces will not cause the LM60's temperature to deviate from the desired temperature.

Alternatively, the LM60 can be mounted inside a sealed-end metal tube, and can then be dipped into a bath or screwed

into a threaded hole in a tank. As with any IC, the LM60 and accompanying wiring and circuits must be kept insulated and dry, to avoid leakage and corrosion. This is especially true if the circuit may operate at cold temperatures where condensation can occur. Printed-circuit coatings and varnishes such as Humiseal and epoxy paints or dips are often used to ensure that moisture cannot corrode the LM60 or its connections.

The thermal resistance junction to ambient ( $\theta_{JA}$ ) is the parameter used to calculate the rise of a device junction temperature due to the device power dissipation. For the LM60 the equation used to calculate the rise in the die temperature is as follows:

$$T_J = T_A + \theta_{JA} [(+V_S I_Q) + (+V_S - V_O) I_L]$$

where  $I_Q$  is the quiescent current and  $I_L$  is the load current on the output.

The table shown in *Figure 3* summarizes the rise in die temperature of the LM60 without any loading, and the thermal resistance for different conditions.

## 1.0 Mounting (Continued)

	SOT-23* no heat sink		SOT-23** small heat fin		TO-92* no heat fin		TO-92*** small heat fin	
	$\theta_{JA}$ (°C/W)	$T_J - T_A$ (°C)	$\theta_{JA}$ (°C/W)	$T_J - T_A$ (°C)	$\theta_{JA}$	$T_J - T_A$	$\theta_{JA}$	$T_J - T_A$
Still air	450	0.17	260	0.1	180	0.07	140	0.05
Moving air			180	0.07	90	0.034	70	0.026

\*-Part soldered to 30 gauge wire.

\*\*-Heat sink used is 1/2" square printed circuit board with 2 oz. foil with part attached as shown in *Figure 2*.

\*\*\*-Part glued or leads soldered to 1" square of 1/16" printed circuit board with 2 oz. foil or similar.

**FIGURE 3. Temperature Rise of LM60 Due to Self-Heating and Thermal Resistance ( $\theta_{JA}$ )**

## 2.0 Capacitive Loads

The LM60 handles capacitive loading well. Without any special precautions, the LM60 can drive any capacitive load as shown in *Figure 4*. Over the specified temperature range the LM60 has a maximum output impedance of 800 $\Omega$ . In an extremely noisy environment it may be necessary to add some filtering to minimize noise pickup. It is recommended that 0.1  $\mu\text{F}$  be added from +V<sub>S</sub> to GND to bypass the power supply voltage, as shown in *Figure 5*. In a noisy environment it may be necessary to add a capacitor from the output to ground. A 1  $\mu\text{F}$  output capacitor with the 800 $\Omega$  output impedance will form a 199 Hz lowpass filter. Since the thermal time constant of the LM60 is much slower than the 6.3 ms time constant formed by the RC, the overall response time of the LM60 will not be significantly affected. For much larger capacitors this additional time lag will increase the overall response time of the LM60.

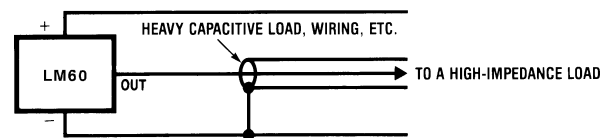

01268115

**FIGURE 4. LM60 No Decoupling Required for Capacitive Load**

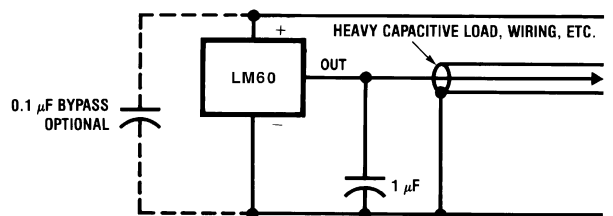

01268116

**FIGURE 5. LM60 with Filter for Noisy Environment**

## 2.0 Capacitive Loads (Continued)

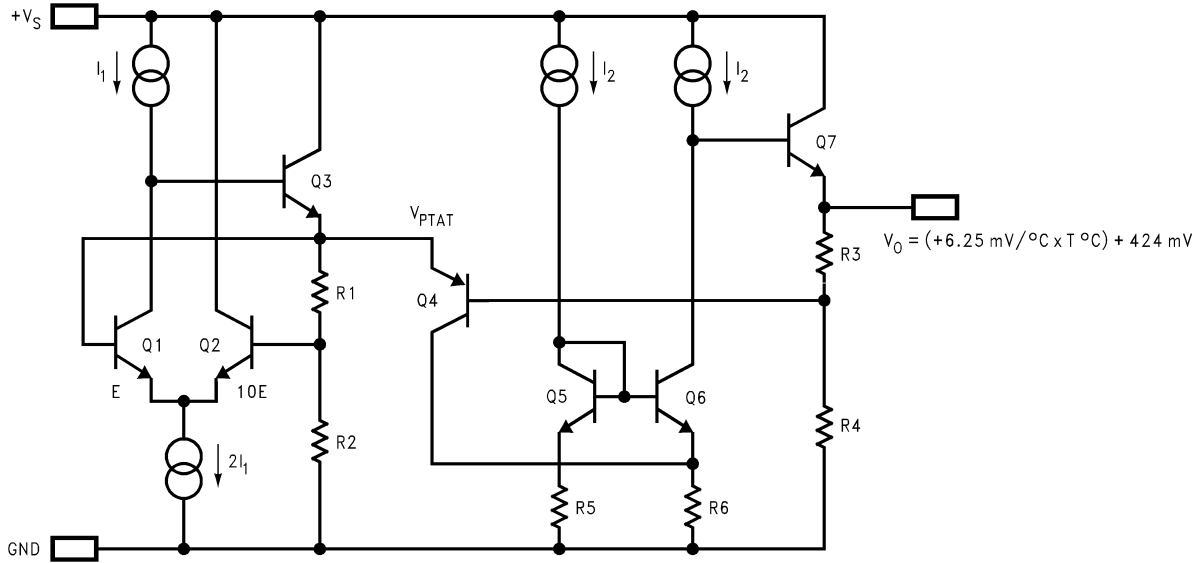

01268117

FIGURE 6. Simplified Schematic

## 3.0 Applications Circuits

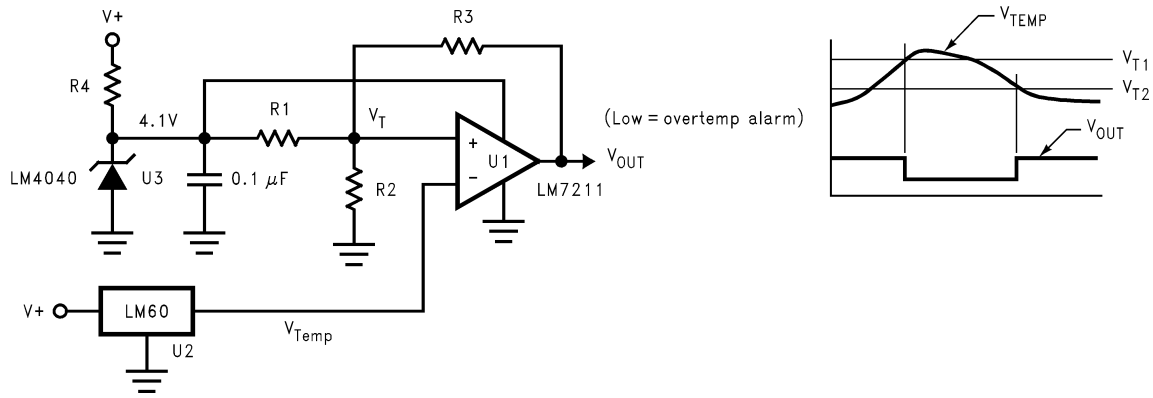

01268118

$$V_{T1} = \frac{(4.1V) R2}{R2 + R1 || R3}$$

$$V_{T2} = \frac{(4.1V) R2}{R2 || R3 + R1}$$

FIGURE 7. Centigrade Thermostat

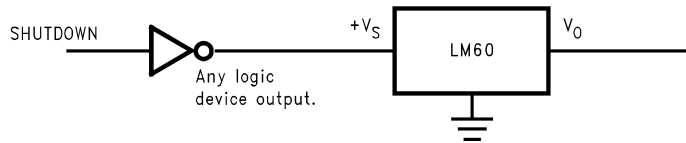

01268119

FIGURE 8. Conserving Power Dissipation with Shutdown

**Physical Dimensions** inches (millimeters)

unless otherwise noted

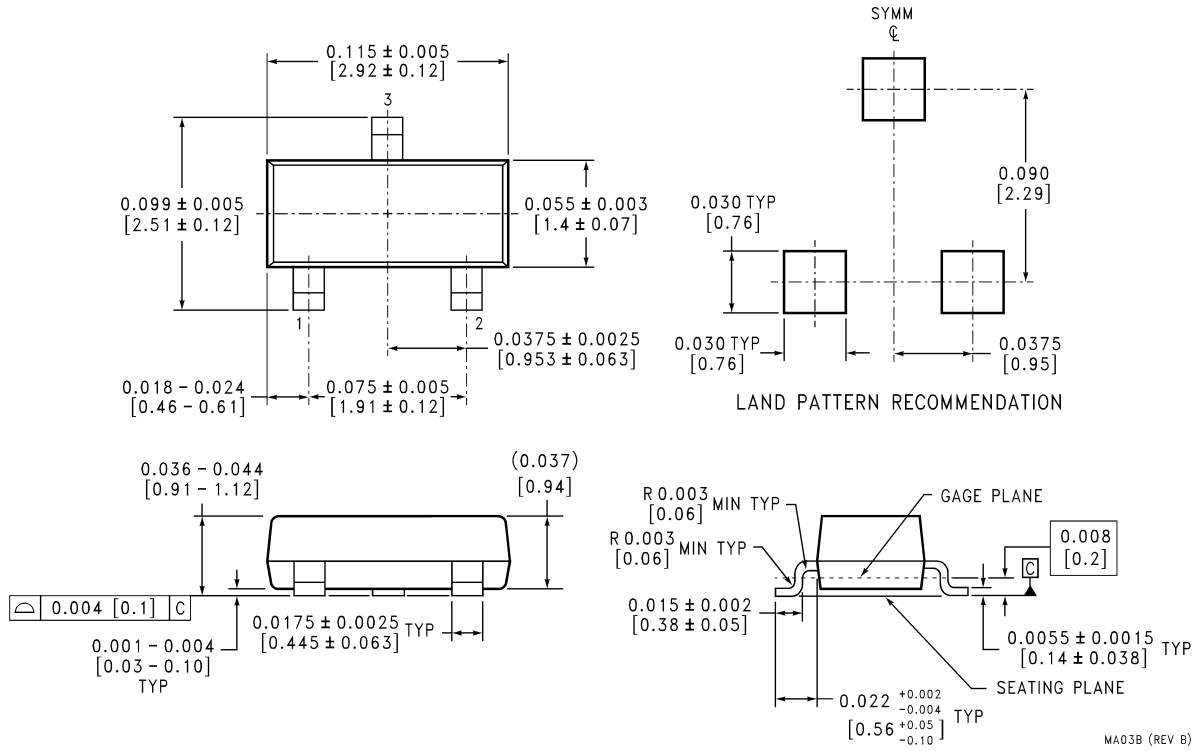

**SOT-23 Molded Small Outline Transistor Package (M3)**  
**Order Number LM60BIM3 or LM60CIM3**  
**NS Package Number MA03B**

MA03B (REV B)



**Physical Dimensions** inches (millimeters) unless otherwise noted (Continued)

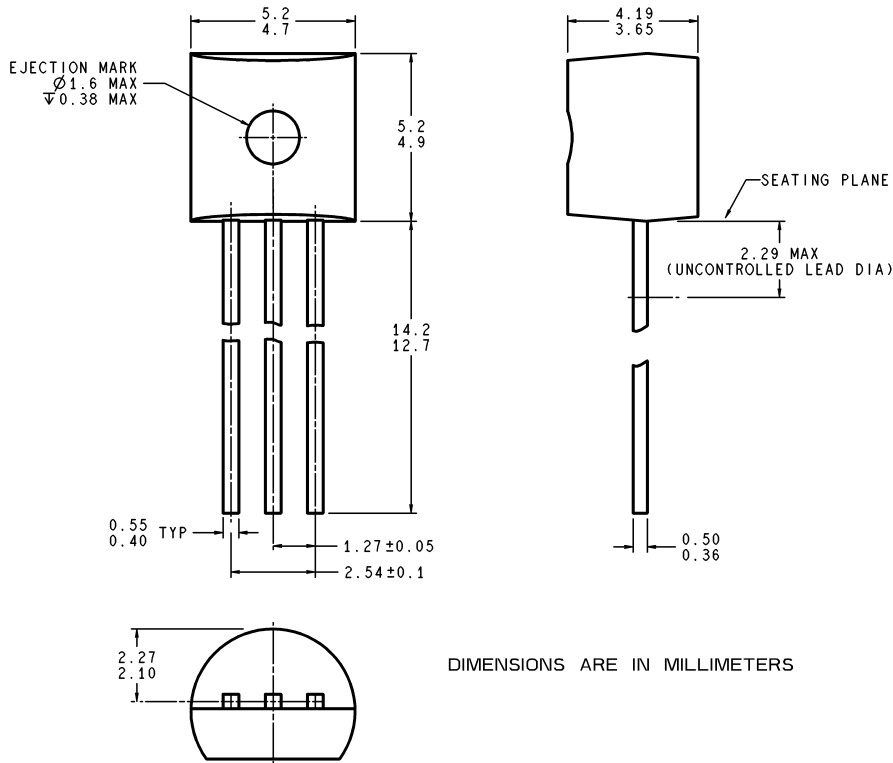

Z03A (Rev G)

**TO-92 Molded Plastic Package (Z)**  
**Order Number LM60BIZ or LM60CIZ**  
**Package Number Z03A**

**LIFE SUPPORT POLICY**

NATIONAL'S PRODUCTS ARE NOT AUTHORIZED FOR USE AS CRITICAL COMPONENTS IN LIFE SUPPORT DEVICES OR SYSTEMS WITHOUT THE EXPRESS WRITTEN APPROVAL OF THE PRESIDENT AND GENERAL COUNSEL OF NATIONAL SEMICONDUCTOR CORPORATION. As used herein:

1. Life support devices or systems are devices or systems which, (a) are intended for surgical implant into the body, or (b) support or sustain life, and whose failure to perform when properly used in accordance with instructions for use provided in the labeling, can be reasonably expected to result in a significant injury to the user.
2. A critical component is any component of a life support device or system whose failure to perform can be reasonably expected to cause the failure of the life support device or system, or to affect its safety or effectiveness.

 **National Semiconductor Corporation**  
Americas  
Email: support@nsc.com

**National Semiconductor Europe**  
Fax: +49 (0) 180-530 85 86  
Email: europe.support@nsc.com  
Deutsch Tel: +49 (0) 69 9508 6208  
English Tel: +44 (0) 870 24 0 2171  
Français Tel: +33 (0) 1 41 91 8790

**National Semiconductor Asia Pacific Customer Response Group**  
Tel: 65-2544466  
Fax: 65-2504466  
Email: ap.support@nsc.com

**National Semiconductor Japan Ltd.**  
Tel: 81-3-5639-7560  
Fax: 81-3-5639-7507

www.national.com